

°caleon

Installation and operating instruction

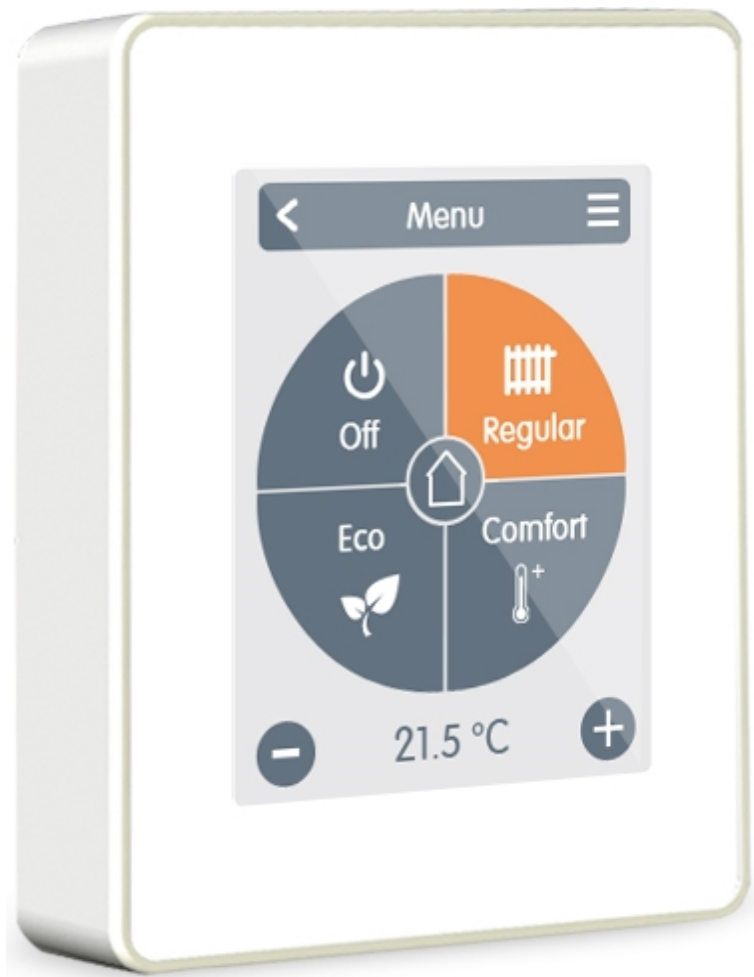

Read carefully before installation, commissioning and operation

CONTENT

Safety Instructions	3
EG-Conformity	3
General Instructions	3
Changes to the Unit	3
Warranty and Liability	3
Disposal and Pollutants	3
Description °CALEON	4
Specifications	4
Scope of Supply	4
Installation	5
°CALEON Installation	5
Example Controller-Connection	7
Example CAN-Connection	7
Operation	8
Room Overview	8
Operating Mode	8
Menu	9
Set Operation Hours	9
Set Operation Hours	10
Expert Menu	11
Settings	11
Devices	12
Rooms	13
Sensors	14
Functions	15
Service Values	17
Notes	18

SAFETY INSTRUCTIONS

EG-Conformity

By affixing the CE mark to the unit the manufacturer declares that °CALEON conforms to the following relevant safety regulations:

- EU low voltage directive 2014/35/EU
- EU electromagnetic compatibility directive 2014/30/EU

conforms. Conformity has been verified and the corresponding documentation and the EU declaration of conformity are kept on file by the manufacturer.

General Instructions

Please read carefully!

These installation and operating instructions contain basic instructions and important information regarding safety, installation, commissioning, maintenance and the optimal use of the unit. Therefore these instructions must be read and understood completely by the installation technician/specialist and by the system user before installation, commissioning and operation of the unit.

This unit is an automatic, electrical °CALEON Room Controller. Install the device only in dry rooms and under environmental conditions as described under "Technical Data".

In addition, observe the applicable accident prevention regulations, the regulations of the Association of Electrical Engineering, the local power supply utility, the applicable DIN-EN standards and the installation and operating instructions for the additional system components. Installation, electrical connection, commissioning and maintenance of the unit may only be carried out by specialists who possess the appropriate training.

Users: Make sure that the specialist gives you detailed information on the function and operation of the unit. Always keep these instructions in the vicinity of the unit.

The manufacturer does not take over any liability for damage caused through improper usage or non-compliance of this manual!

Changes to the Unit

- Changes, additions to or conversion of the unit are not permitted without written permission from the manufacturer.
- It is likewise forbidden to install additional components that have not been tested together with the unit.
- If it becomes clear that safe operation of the unit is no longer possible, for example because of damage to the housing, turn the Unit off immediately.
- Any parts of the unit or accessories that are not in perfect condition must be exchanged immediately.
- Use only original spare parts and accessories from the manufacturer.
- Markings made on the unit at the factory must not be altered, removed or made illegible.
- Only the settings described in these instructions may be set using the Unit.



Changes to the unit can compromise the safety and function of the unit or the entire system.

Warranty and Liability

The Unit has been manufactured and tested with regard to high quality and safety requirements. The warranty and liability shall not include, however, any injury to persons or material damage that is attributable to one or more of the following causes:

- Failure to observe these installation and operating instructions.
- Improper installation, commissioning, maintenance and operation.
- Improperly executed repairs.
- Unauthorised structural changes to the unit.
- Use of the device for other than its intended purpose.
- Operation above or below the limit values listed in the 'Specifications' section.
- Force majeure.

Disposal and Pollutants

The unit conforms to the European RoHS 2011/65/EU for 2011/65/EU the restriction of the use of certain hazardous substances in electrical and electronic equipment.



Under no circumstances may the device be disposed of with the normal household waste. Dispose of the unit only at appropriate collection points or ship it back to the seller or manufacturer.

DESCRIPTION °CALEON

Specifications



	Housing	2-part, ABS plastic 75 mm x 95 mm x 19 mm Glass front
	Display	Capacitive touch panel Color display with 240x320 dots 2.8 inches (7 cm) diagonal
	Operation	Intuitive user guidance
	Language	Deutsch English Español Italiano Français Português

Electrical specifications:

Power supply	24 VDC +/- 10%
power consumption	max. 2,5 W
Protection Class	IP20
Protection class / overvoltage category	

Max. cable length

1-Wire Bus	Optional, without function
------------	----------------------------

Permissible Ambient Conditions

during operation	0 °C - 50 °C, no moisture condensation permitted
for transport/storage	0 °C - 60 °C, no moisture condensation permitted

Measuring range

Outside the measuring ranges there are larger deviations	
Internal temperature sensor	0 °C - 60 °C Accuracy +/- 1 °C Resolution 0,1 °C
Internal sensor for rel. humidity	0 % - 100 % Accuracy +/- 6 °C Resolution 0,1 %
1-Wire temperature sensors	Optional, without function

Other Specifications

Installation methods	Wall installation, with/without wall socket
Real Time Clock	RTC with 24 hour power reserve

Scope of Supply

- °CALEON Room Controller
- 2 screws 3,5 x 35 mm and 2 plugs 6 mm for wall installation.
- °CALEON installation guide

°CALEON Installation

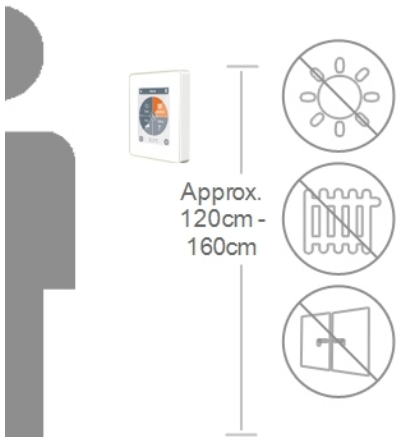

Mount the unit at a suitable location.



Pay attention to suitable environmental conditions. Direct sunlight, sources of heat and cold, e.g. radiators and windows must be avoided.

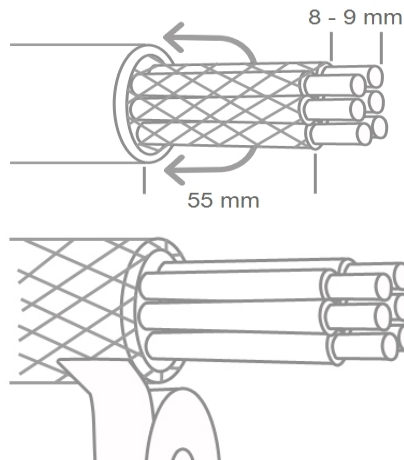

When mounting °CALEON's base to the wall the connecting cables must be kept as short as possible. For direct wall mounting a maximum length of 40 mm is recommended. Long wire loops inside the °CALEON's housing may cause problems.

When mounting °CALEON's base to a plastic wall socket the connecting cables must be kept as short as possible (strip cables not more than 55 mm). Also make sure that wire loops are led back to the plastic wall socket, since long wire loops inside the °CALEON's housing may cause problems.

Strip the last 8 - 9 mm of the wires. Isolate shielding and connect it at a suitable location (controller or CAN-box) to the protective conductor.



Any contact between protective conductor and circuit board can cause serious damage.

Mounting on plastic wall socket

Fix the base with the screws (3.0 x 16) to the mounting box.

Direct wall mounting

Hold the lower part of the housing up to the selected position and mark the three mounting holes. Make sure that the wall surface is as even as possible so that the housing does not become distorted when screwed on. Using a drill and drill holes at the points marked on the wall and push in the plugs. Insert screws and screw it in slightly. Align the base and tighten the screws.

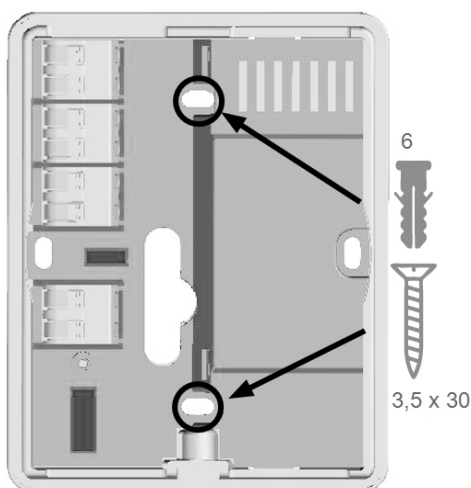

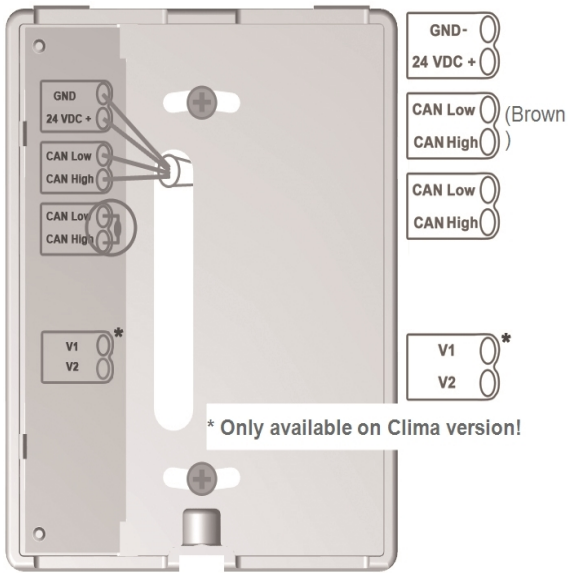

Open the terminals with the accompanying operating tool and make the electrical connection as described.

! Power supply 24 VDC, ensure correct polarity or it may cause damage to the unit!

! The first and last unit in the CAN-network in series must be fitted with terminating resistance.



The connection of the opposite side (controller) can be found in the corresponding terminal diagram in the controller manual.

Refit the base and fasten with screw. Switch on mains voltage and place °CALEON in operation.

! The commissioning can be accessed in the °CALEON menu under Expert at any time.

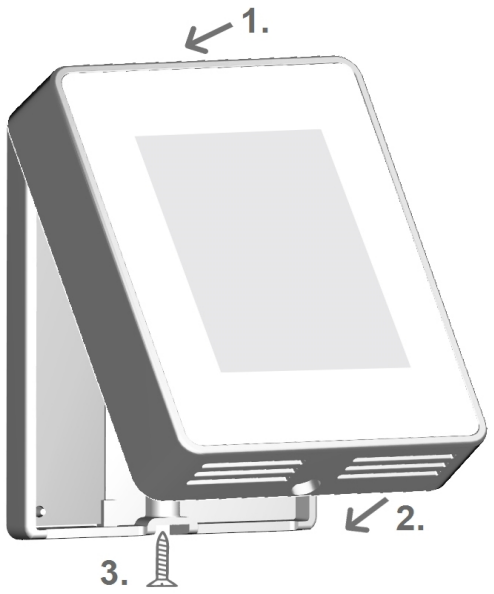

Example Controller-Connection

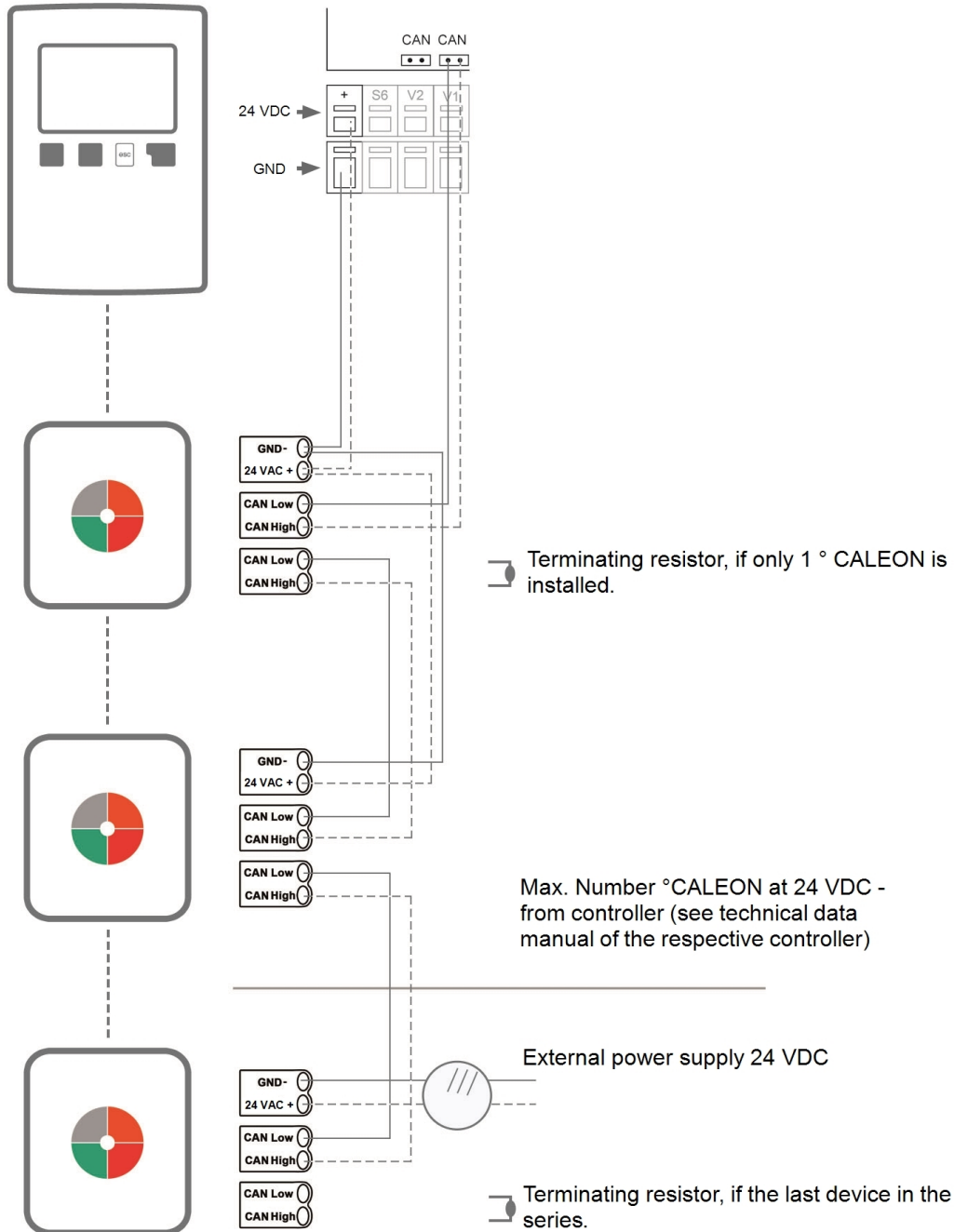

Example CAN-Connection

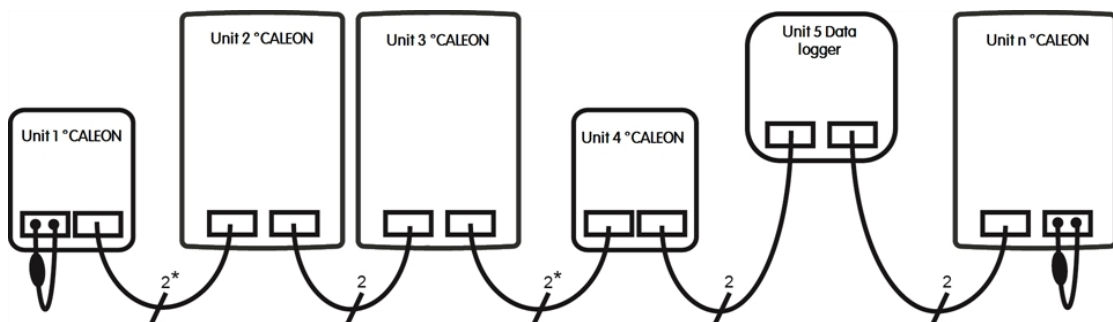

*Only CAN in power supply from 4 cores of the regulator.

The order and the number of devices (max. 50) is arbitrary.

OPERATION

Room Overview

Displays the room temperature, humidity and external temperature once the start screen was activated.

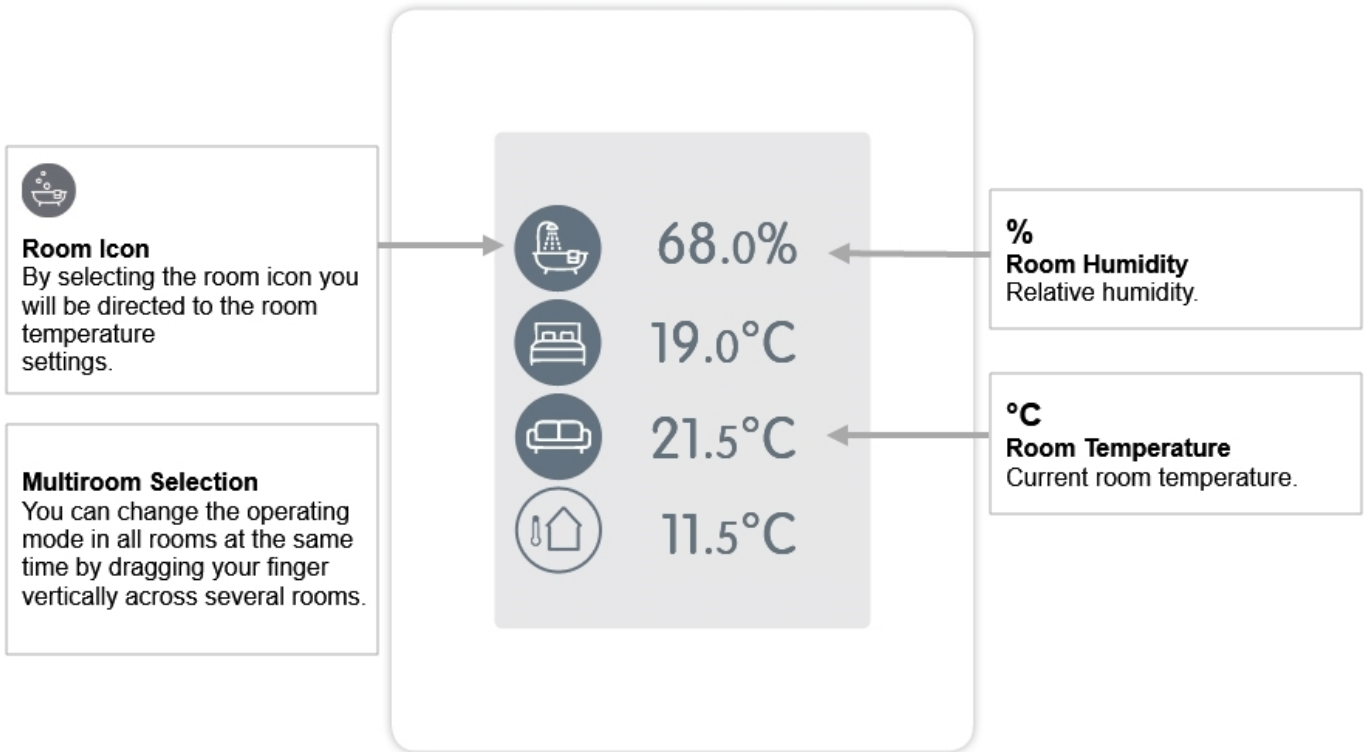

Operating Mode

Overview > Operating Mode

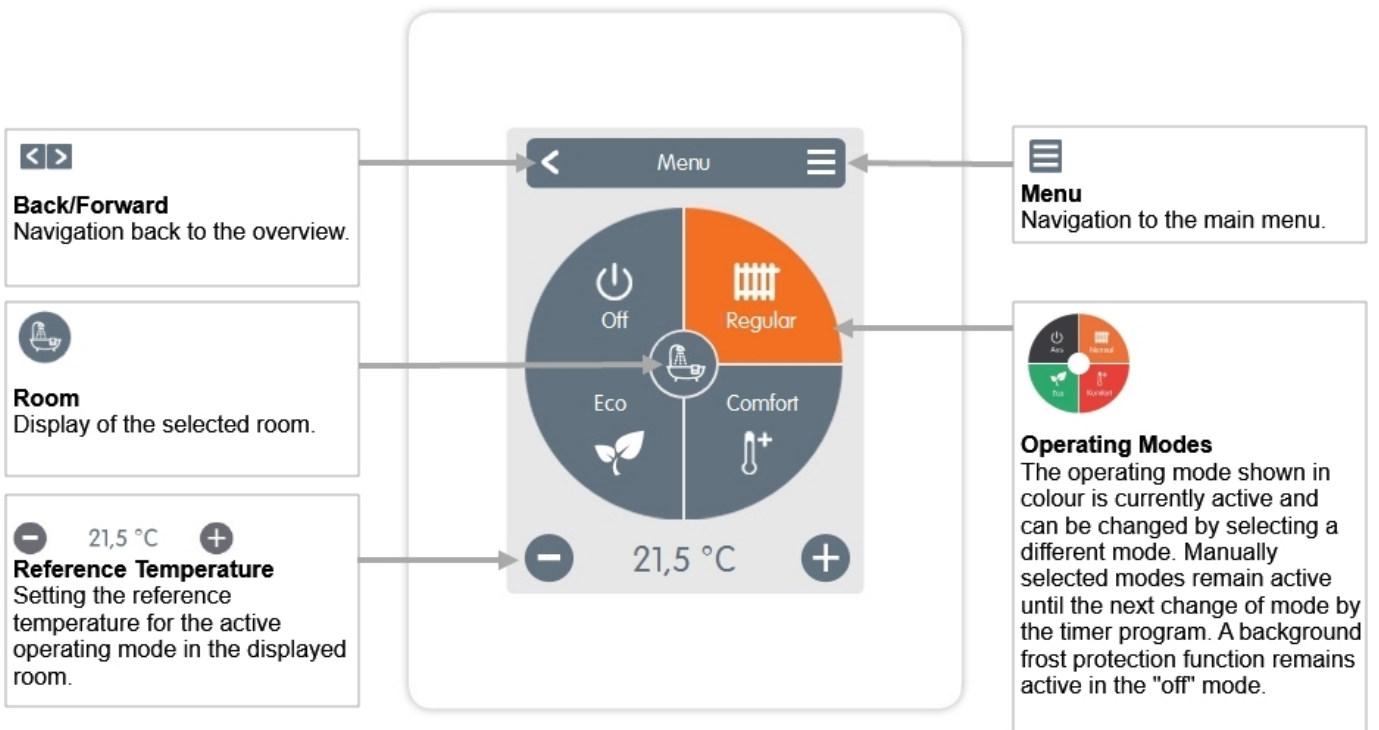

Menu

Overview > Operating Mode > Menu

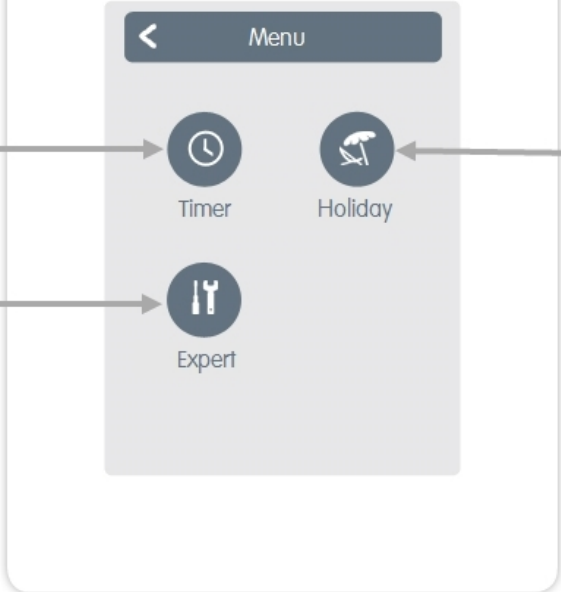

The screenshot shows a 'Menu' screen with a back arrow and three options: 'Timer' (clock icon), 'Holiday' (umbrella icon), and 'Expert' (wrench icon). Arrows point from descriptive boxes to these options.

Timer
Setting of individual heating and cooling times for each day of the week including a copy function for following days.

Expert
Advanced settings for technicians.

Holiday
Sets the duration and temperature for a longer absence.

Set Operation Hours

Overview > Operating Mode > Menu > Timer

Setting of individual heating and cooling times for the selected room.

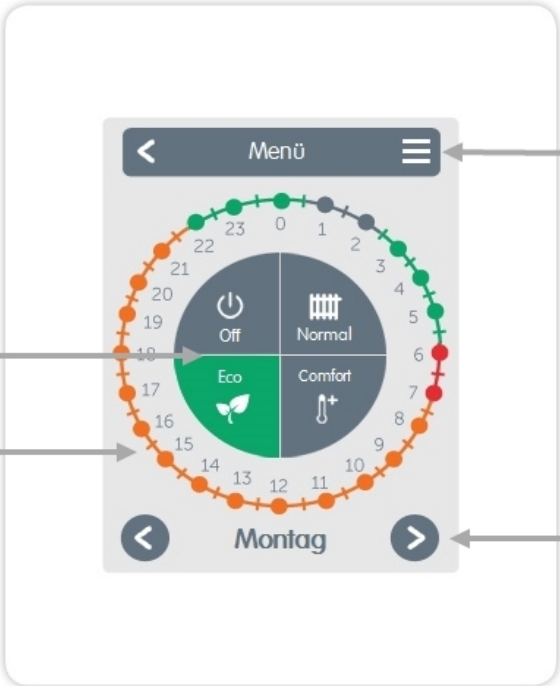

The screenshot shows a 'Menü' screen with a circular clock interface. The clock has segments for different times of the day, colored according to the selected operating mode. The modes are 'Aus' (power off), 'Normal', 'Eco', and 'Komfort'. The clock is currently set to 'Montag' (Monday). Arrows point from descriptive boxes to various elements of the interface.

Operating Modes
Selection of the operating mode to select individual heating or cooling sections.

Clock
Time table for selecting the time intervals in 30-minute steps. Touch individual segments, or drag your finger over complete time intervals to colour them according to the selected operation mode.

Menu
Opens the copy function. The function allows you to copy the heating and cooling times to the following day, to Monday - Friday or to Monday - Sunday.

Back/Next Weekday
Selection of the day of week which is to be set.

Set Operation Hours

Step 1
Use the arrow keys to select the desired day.



Step 2
Select the first heating mode (normal) - move the index finger over the desired length of time. The selected period will be coloured after selecting the colour of the operating mode (normal = orange). Set the times of the other operating modes in the same way.

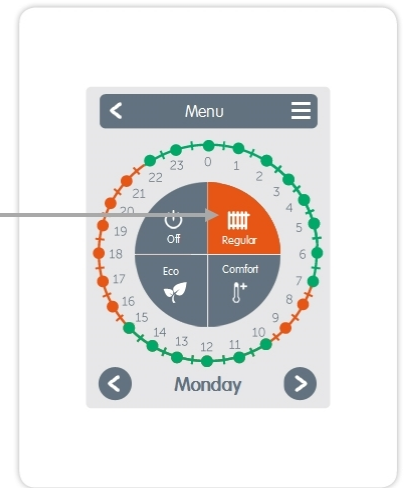

Step 3
After completing the setting of the individual heating and cooling times, you have the option of copying the times via the main menu to the following day, to Monday - Friday or to Monday - Sunday or individually for each weekday.

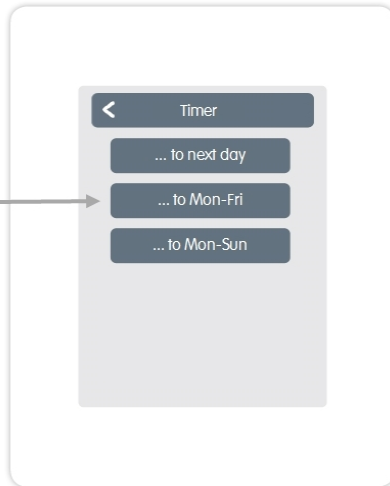

In the interests of efficient and energy-saving single room control, the operating times should be set specifically for each room.

Expert Menu

Overview > Operating Mode > Menu > Expert

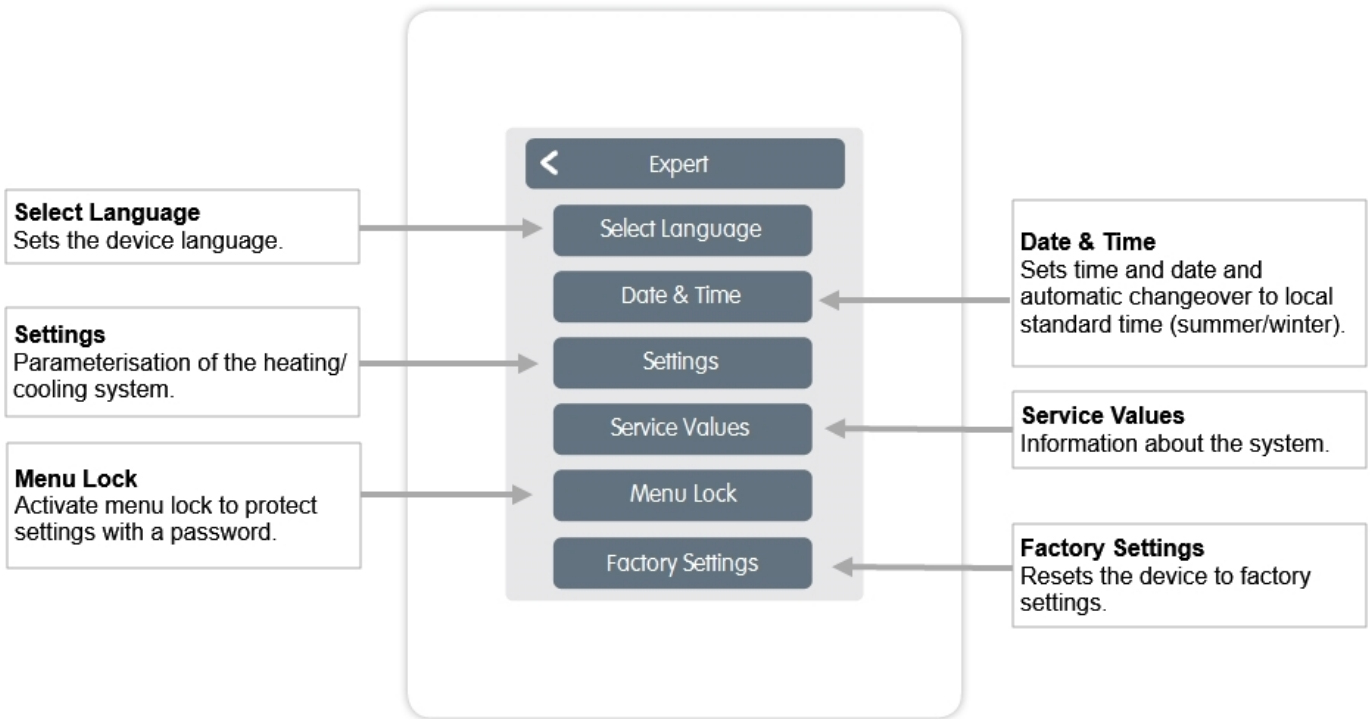

 The menu structure described here is based on the status at the time of production and may vary due to subsequent software changes.

Settings

Overview > Operating Mode > Menu > Expert > Settings

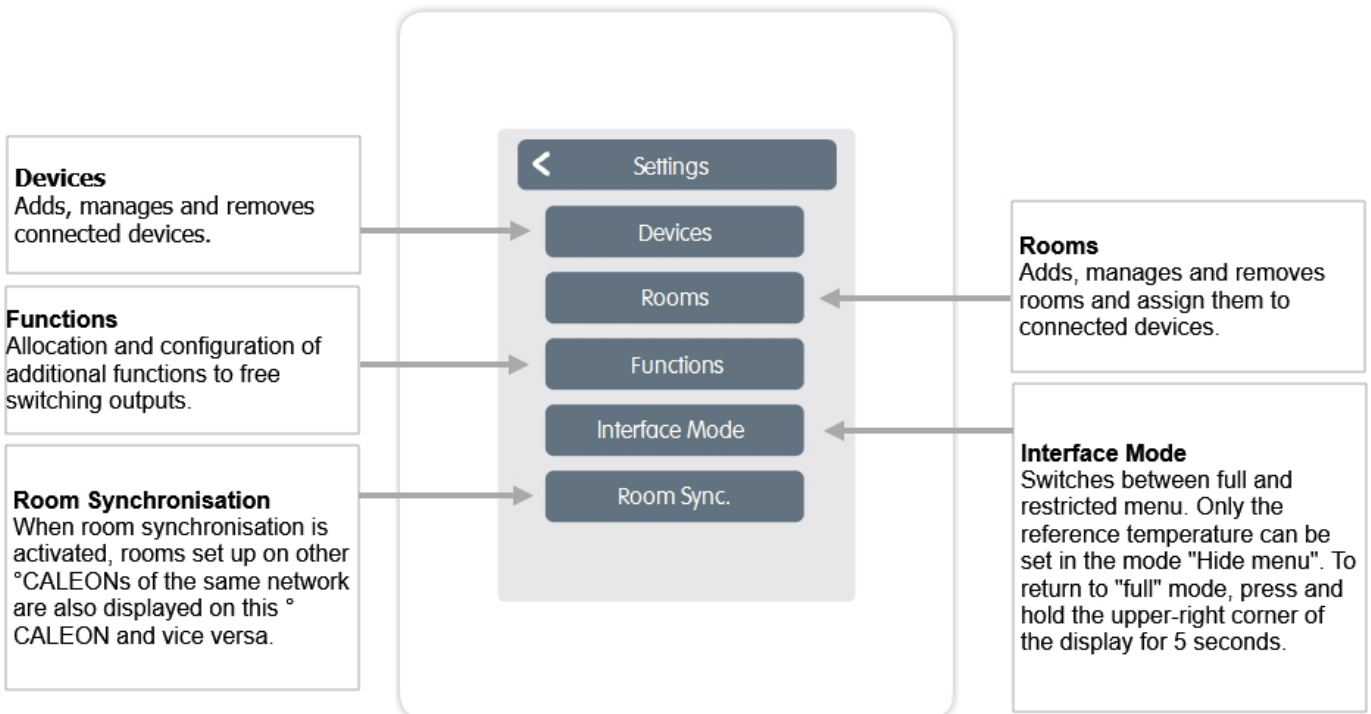

Devices

Overview > Operating mode > Menu > Expert > Settings > Devices

+
Add Device
Starts a search in the network for new, available devices.

Device Icon
Shows the type of connected device and its CAN-ID.

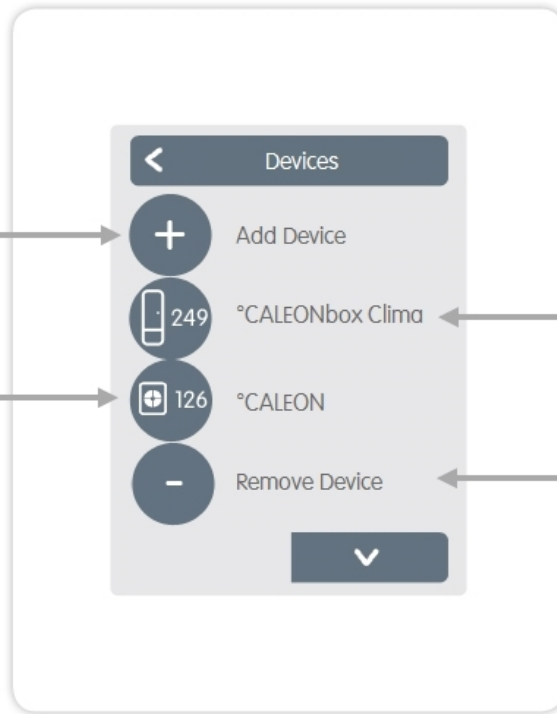

Designation
Indicates the type of device detected.

-
Remove Device
The device will be removed from the network.

Overview > Operating mode > Menu > Expert > Settings > Devices > °CALEON

Sensor Offset
Manual correction of sensor values.

Network Reset
Deletes all devices from the network and starts search for available devices.

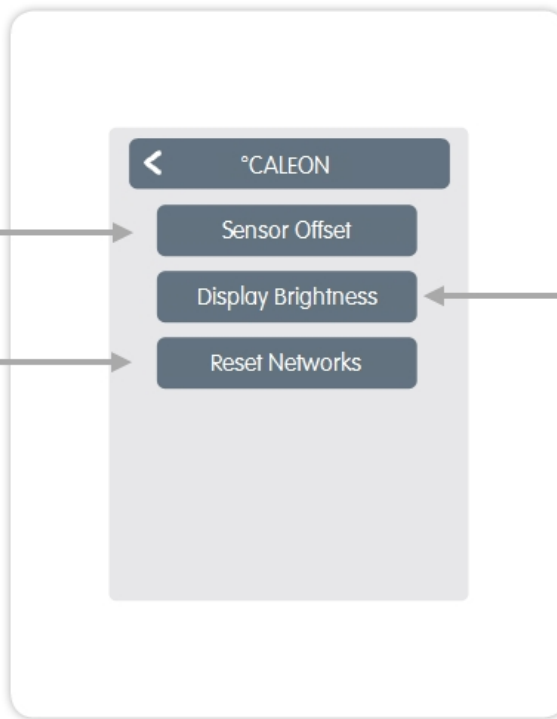

Display Brightness
Adjust the display brightness.

Rooms

Overview > Operating mode > Menu > Expert > Settings > Rooms

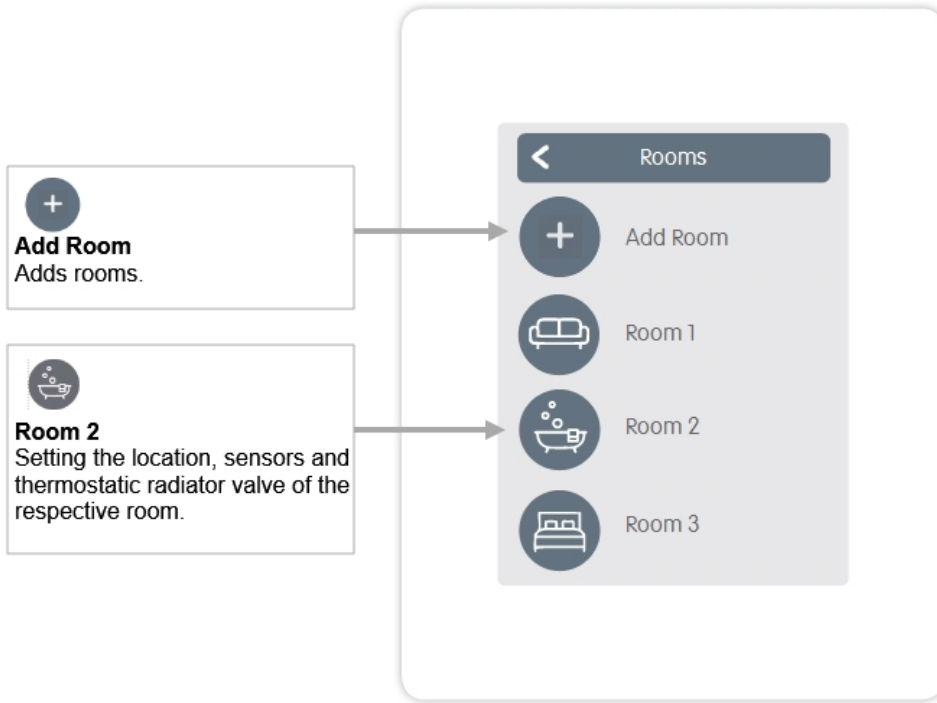

Overview > Operating mode > Menu > Expert > Settings > Room 2

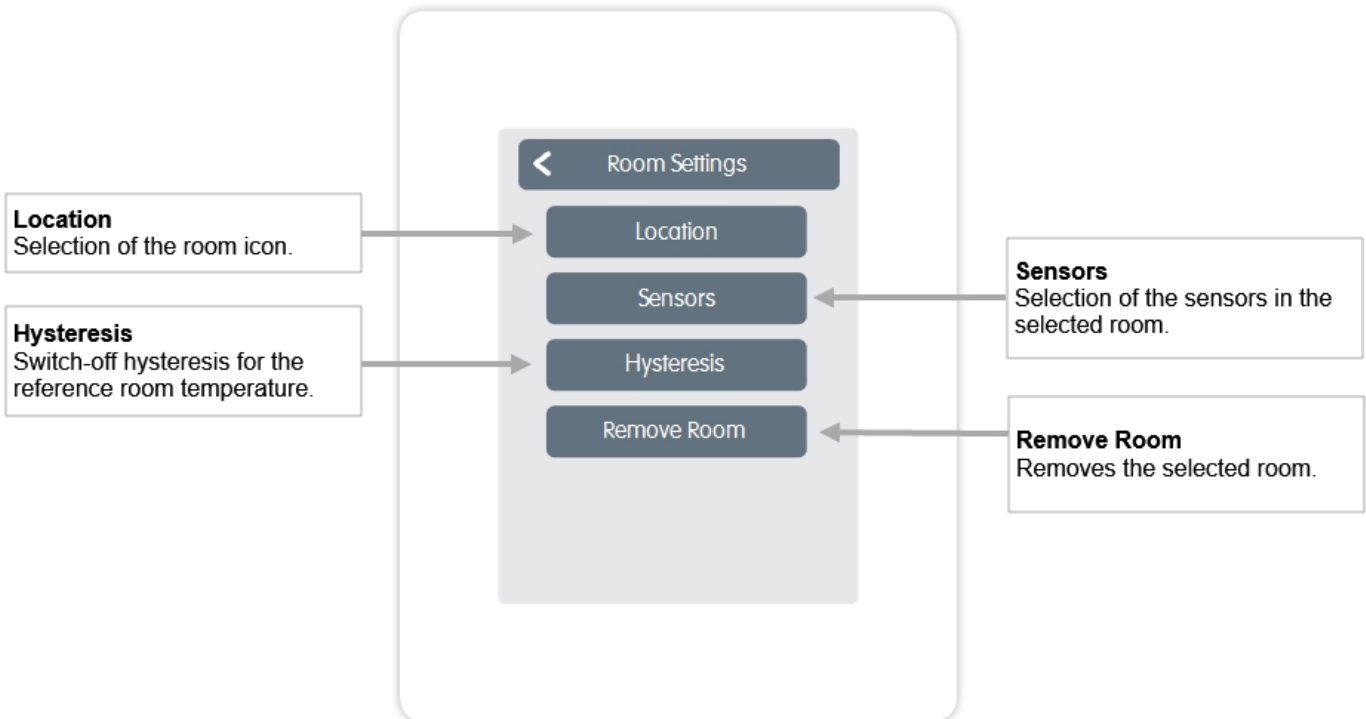

Sensors

Overview > Operating mode > Menu > Expert > Settings > Rooms > Room 1 > Sensors

Temperature Sensor
Sensors in the selected room.

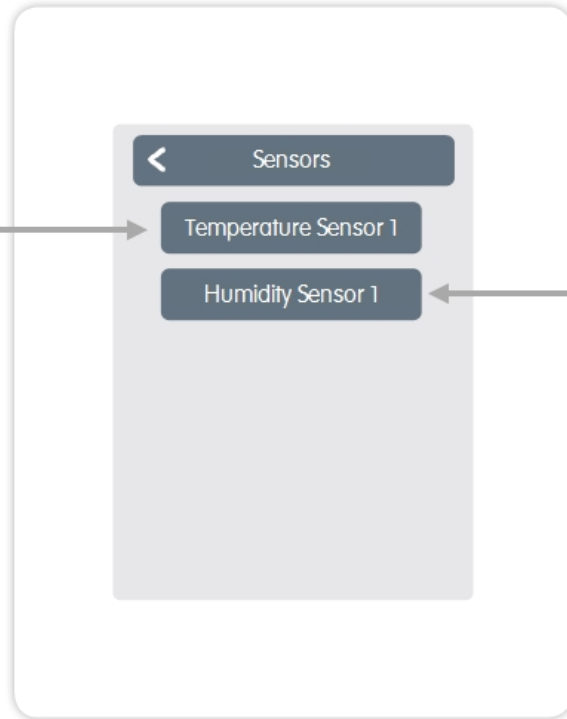

Humidity Sensor 1
Sensors in the selected room.

Overview > Operating mode > Menu > Expert > Settings > Rooms > Room 1 > Sensors > Temperature Sensor 1

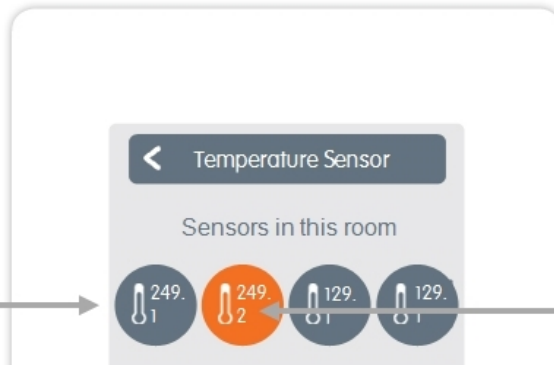

Sensor icon with CAN-ID + number
Selection of temperature sensor in the selected room.



Icon
Already selected sensor.

Overview > Operating mode > Menu > Expert > Settings > Rooms > Room 1 > Sensors > Humidity Sensor 1

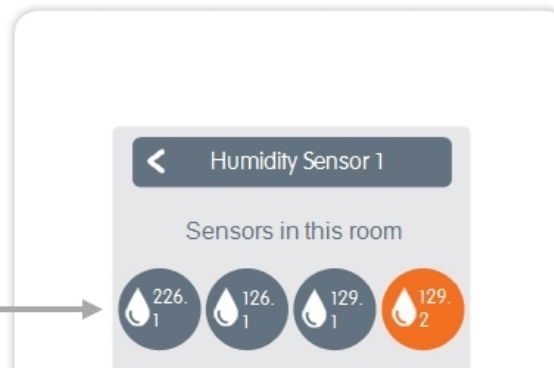

Sensor icon with CAN-ID + number
Selection of the humidity sensor in the selected room.



Functions

Overview > Operating mode > Menu > Expert > Settings > **Functions**

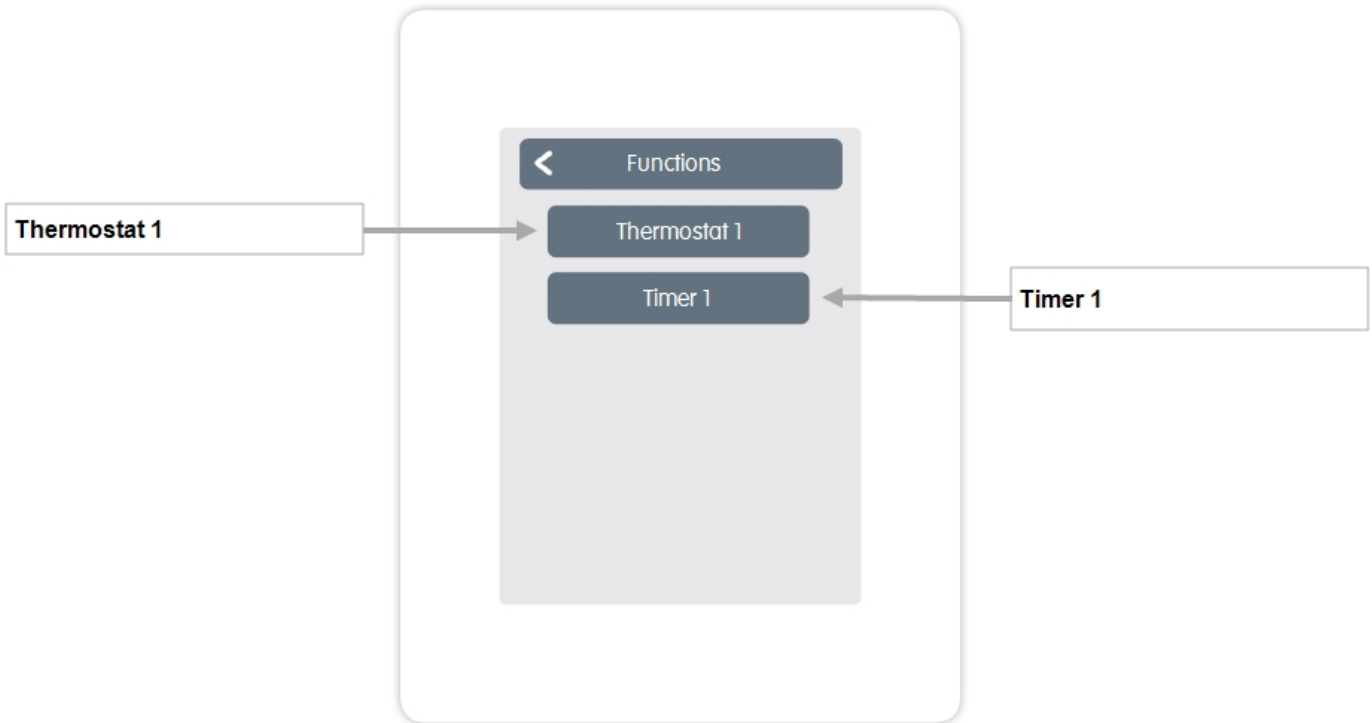
Activate and set additional functions.



Overview > Operating mode > Menu > Expert > Settings > Functions > **Thermostat 1**

Switches the defined output to the set room / rooms depending on time and temperature.

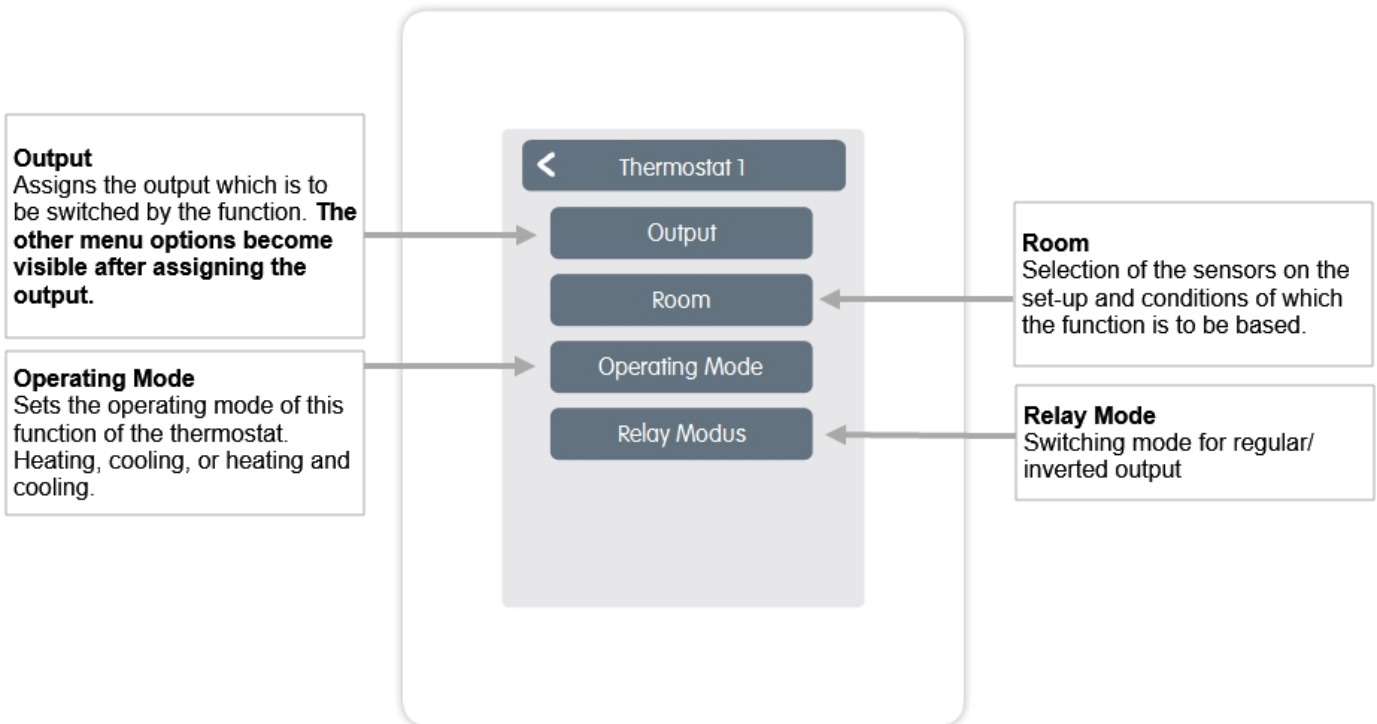

The function Timer 1 switches the defined output depending on the set times.

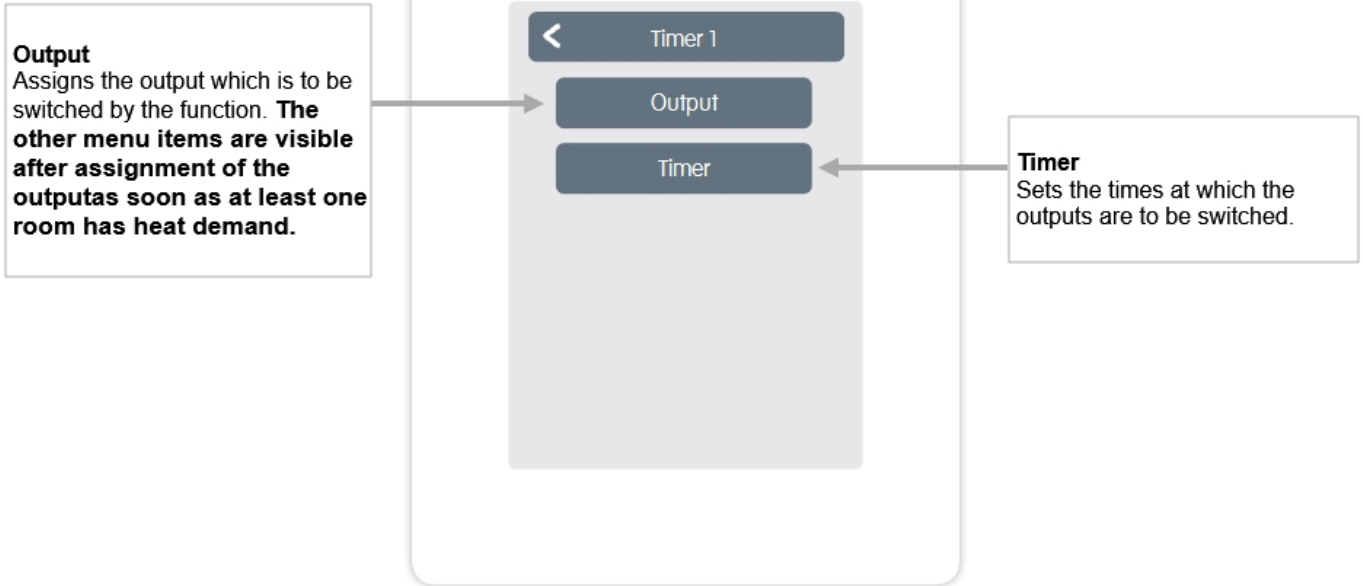

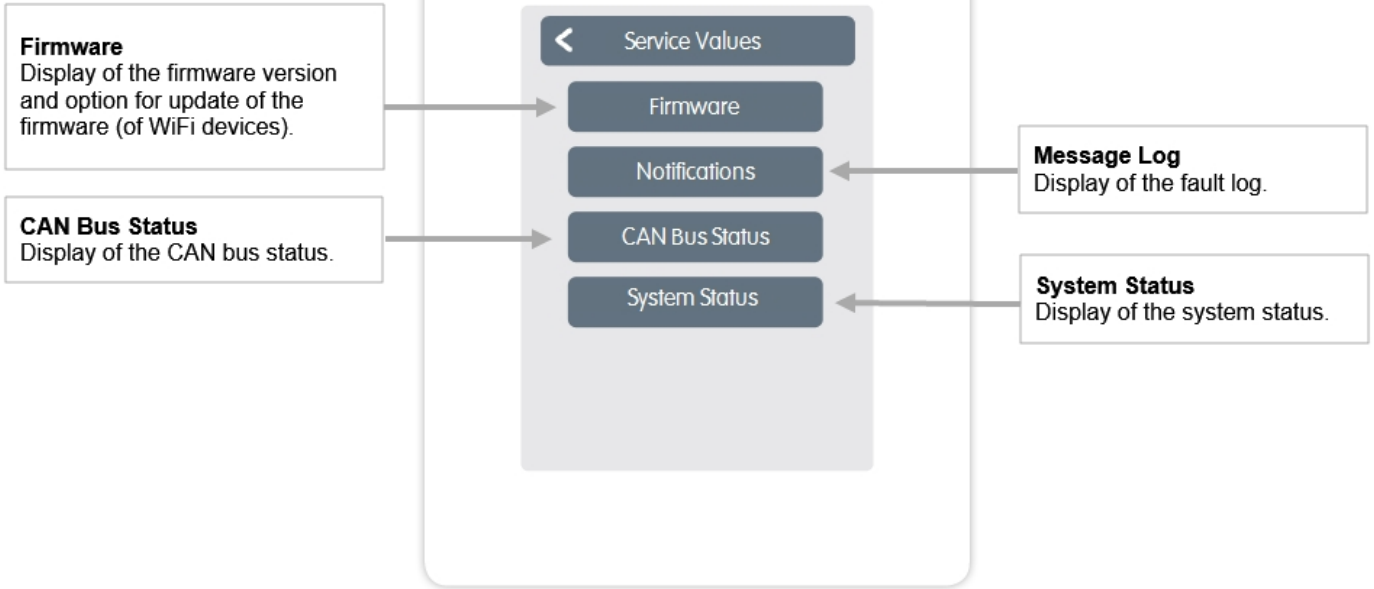

Final Declaration

Although these instructions have been created with the greatest possible care, the possibility of incorrect or incomplete information cannot be excluded. Subject as a basic principle to errors and technical changes.

Date and time of installation:

Name of installation company:

Space for notes:

Your specialist dealer:

Manufacturer:

SOREL GmbH Mikroelektronik
Reme-Str. 12
D - 58300 Wetter (Ruhr)

+49 (0)2335 682 77 0
+49 (0)2335 682 77 10

info@sorel.de
www.sorel.de

Version: 05.04.2019