

115V Version

# Heating-Controller HCC 4

Weathercontrolled heat circuit regulator

**Installation and operating instructions**



**Read carefully before installation, commissioning and operation**

---

## Table of content

Chapter	Page	Chapter	Page
<b>1 Safety instructions</b>		<b>10 Settings HC Menu 5</b>	
1.1 EC conformity	3	10.1 Su/Wi Day	20
1.2 General instructions	3	10.2 Su/Wi Night	20
1.3 Explanation of symbols	3	10.3 Curve	21
1.4 Changes	4	10.4 Day correction	22
1.5 Warranty	4	10.5 Night correction	22
		10.6 Comfort boost	22
		10.7 Reference/actual-	23
		10.8 Reference/actual+	23
<b>2 Description of controller</b>		<b>11 Settings HC2 Menu 6</b>	
2.1 Specifications	5	10.3 Curve	24
2.2 About the controller	6	10.4 Day correction	25
2.3 Scope of supply	6	10.5 Night correction	25
2.4 Disposal of pollutants	6	10.6 Comfort boost	25
2.5 Hydraulic variants	7		
<b>3 Installation</b>		<b>12 Protective functions Menu 7</b>	
3.1 Wall installation	8	12.1 Anti seizing	26
3.2 Electrical connection	9-10	12.2 Frost protection	26
3.3 Installing the sensors	11	12.3 Min. flow	26
3.4 Installing RS-485	11	12.4 Max. flow	27
3.5 External error condition		12.5 Max. flow 2	27
<b>4 Operation</b>		<b>13 Special functions Menu 8</b>	
4.1 Display and input	12	12.1 Sensor calibration	28
4.2 Menu sequence	13	12.2 Commissioning	28
		12.3 Factory settings	28
<b>5 Parametrisation</b>		12.4 Expansions	29
5.1 Commissioning help	14	12.5 Mixer	29
5.2 Free commissioning	14	12.6 Turn-time	29
		12.7 Pause factor	29
<b>6 Measurement values</b>	15	12.8 Increase	29
		12.9 Room controller	30
<b>7 Statistics</b> Menu 1 Menu 2		<b>14 Menu lock Menu 9</b>	31
7.1 24 hours	16	<b>15 Language Menu11</b>	31
7.2 28 days	16	<b>16 Service values Menu 10</b>	32
7.3 Operating hours HC	16	<b>17 Malfunctions/Maintenance</b>	
7.3 Operating hours HC 2	16	17.1 Error messages	33
7.4 Error messages	16	17.2 Replacing the fuse	34
7.5 Reset/clear	16	17.3 Maintenance	34
<b>8 Operating times Menu 3</b>		<b>18 Useful notes/tips&amp;tricks</b>	35
8.1 time & date	17		
8.2-8.4 Heat circuit day	17		
8.5-8.7 Heat circuit conf.	17		
<b>9 Operating modes Menu 4</b>			
9.1 Heat circuit	18		
9.2 Manual	19		
9.3 Heat circuit reference	19		
9.4 14 day reference value	19		

### 1.1 EC declaration of conformity

By affixing the CE mark to the unit the manufacturer declares that the HCC4 conforms to the following relevant safety regulations:

- EC low voltage directive  
73/23/EEC, as amended by 93/68/EEC
- EC electromagnetic compatibility directive  
89/336/EEC version 92/31/EEC version 93/68/EEC

Conformity has been verified and the corresponding documentation and the EC declaration of conformity are kept on file by the manufacturer.

### 1.2 General instructions **It is essential that you read this!**

These installation and operating instructions contain basic instructions and important information regarding safety, installation, commissioning, maintenance and the optimal use of the unit. Therefore these instructions must be read completely and understood by the installation technician/specialist and by the system user before installation, commissioning and operation of the unit.

The valid accident prevention regulations, VDE regulations, the regulations of the local power utility, the applicable DIN-EN standards and the installation and operating instruction of the additional system components must also be observed. The controller does not under any circumstances replace any safety devices to be provided by the customer!

Installation, electrical connection, commissioning and maintenance of the unit may only be carried out by specialists who possess the appropriate training.

For the user: Make sure that the specialist gives you detailed information on the function and operation of the controller. Always keep these instructions in the vicinity of the controller.

### 1.3 Explanation of symbols



**Danger**

Failure to observe these instructions can result in danger to life from electric voltage.



**Danger**

Failure to observe these instructions can result in serious damage to health such as scalding, or even life-threatening injuries.



**Caution**

Failure to observe these instructions can result in destruction of the unit or the system, or damage to the environment.



**Caution**

Information which is especially important for the function and optimal use of the unit and the system.

#### 1.4 Changes to the unit



Changes to the unit can compromise the safety and function of the unit or the entire system.

- Changes, additions to or conversion of the unit are not permitted without written permission from the manufacturer
- It is likewise forbidden to install additional components that have not been tested together with the unit
- If it becomes clear that safe operation of the unit is no longer possible, for example because of damage to the housing, then turn the controller off immediately
- Any parts of the unit or accessories that are not in perfect condition must be exchanged immediately
- Use only original spare parts and accessories from the manufacturer.
- Markings made on the unit at the factory must not be altered, removed or made illegible
- Only the settings actually described in these instructions may be made on the controller

#### 1.5 Warranty and liability

The controller has been manufactured and tested with regard to high quality and safety requirements. The unit is subject to the statutory guarantee period of two years from the date of sale.

The warranty and liability shall not include, however, any injury to persons or material damage that is attributable to one or more of the following causes:

- Failure to observe these installation and operating instructions
- Improper installation, commissioning, maintenance and operation
- Improperly executed repairs
- Unauthorised structural changes to the unit
- Installation of additional components that have not been tested together with the unit
- Any damage resulting from continued use of the unit despite an obvious defect
- Failure to use original spare parts and accessories
- Use of the device for other than its intended purpose
- Operation above or below the limit values listed in the specifications
- Force majeure

## 2.1 Specifications

### Electrical specifications:

Mains Voltage	115VAC +/- 10%
Mains frequency	50...60Hz
Power consumption	2VA
Total switched power	460VA (Relay outputs 1-5)
Switched power per relay	460VA for AC1 / 185W for AC3
Internal fuse	2A slow blow 250V
Protection category	IP40
Protection class	II
Sensor inputs	5x Pt1000 temperature sensor 1x Room
Measuring range	-40 to 110°C

### Permissible ambient conditions:

Ambient temperature	
for controller operation	0°C...40°C
for transport/storage	0°C...60°C
Air humidity	
for controller operation	max. 85% humidity at 25°C
for transport/storage	no moisture condensation permitted

### Other specifications and dimensions

Housing design	2-part, ABS plastic
Installation methods	Wall installation, optionally panel installation
Overall dimensions	163mm x 110mm x 52mm
Aperture installation dimensions	157mm x 106mm x 31mm
Display	Fully graphical display 128 x 64 dots
Light diode	Multicolour
Operation	4 entry keys

### Temperature sensors:

	(may not be included in the scope of supply)
Immersion sensor	Pt1000, e.g. immersion sensor TT/P4
Pipe-mounted sensor	Pt1000, e.g. pipe-mounted sensor TR/P4
Outdoor sensor	Pt1000, e.g. outdoor sensor TA52
Remote adjuster	Pt1000, Typ RC21
Sensor leads	2x0.75mm <sup>2</sup> extendable up to 30m

### Temperature resistance table for Pt1000 sensors

°C	0	10	20	30	40	50	60	70	80	90	100
Ω	1000	1039	1077	1116	1155	1194	1232	1270	1308	1347	1385

## 2.2 About the controller

The weather controlled Heat Circuit Controller HCC 4 facilitates efficient use and function control of your heating system. The device is impressive most of all for its functionality and simple, almost self-explanatory operation. For each step in the input process the individual entry keys are assigned to appropriate functions and explained. The controller menu contains headwords for the measured values and settings, as well as help texts or clearly-structured graphics.

Important characteristics of the HCC4:

- Depiction of graphics and texts in a lighted display
- Simple viewing of the current measurement values
- Statistics and monitoring of the system by means of statistical graphics, etc.
- Extensive setting menus with explanations
- Menu block can be activated to prevent unintentional setting changes
- Resetting to previously selected values or factory settings
- various additional functions are available e.g. 0...10V connection for boiler control

## 2.3 Scope of supply

- Heating controller HCC4
- 3 screws 3,5x35mm and 3 plugs 6mm for wall installation
- 6 strain reliefs with 12 screws, replacement fuse 2AT
- installation and operating instructions HCC4

Optionally contained depending on design/order:

- 1x outdoor sensor e.g. TA52 (Pt1000)
- 1-2x pipe-mounted sensor e.g. TR/P4 (Pt1000)
- 1x buffersensor e.g. TT/P4 (Pt1000)
- 1x Indoor sensor/remote adjuster with mode switch RC21
- 1x Immersion sleeve e.g. TH150
- various additional functions expansion boards

## 2.4 Disposal and pollutants

The unit conforms to the European RoHS directive 2002/95/EC for the restriction of the use of certain hazardous substances in electrical and electronic equipment.



Caution

The unit must not under any circumstances be disposed of with ordinary household refuse. Dispose of the unit only at appropriate collection points or ship it back to the seller or manufacturer.

## 2.5 Hydraulic variants



Caution

The following illustrations should be viewed only as schematic diagrams showing the respective hydraulic systems, and do not claim to be complete. The controller does not replace safety devices under any circumstances. Depending on the specific application, additional system components and safety components may be mandatory, such as check valves, non-return valves, safety temperature limiters, scalding protectors, etc., and must therefore be provided.

- ① Regulated heating circuit without add. heating without buffer

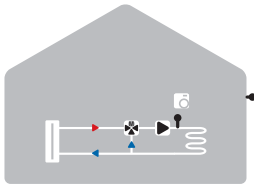

- ② Regulated heating circuit with add. heating without buffer

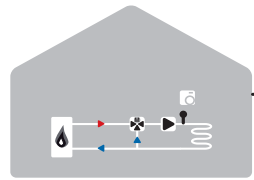

- ③ Regulated heating circuit with add. heating with buffer

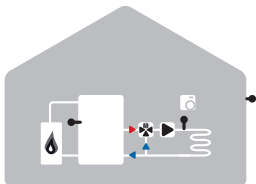

- ④ 2 heat. circuits (reg./not reg.) with add. heating without buffer

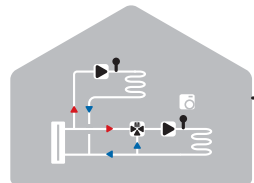

- ⑤ 2 heat. circuits (reg./not reg.) with add. heating without buffer

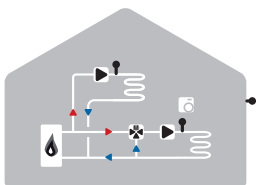

- ⑥ 2 heat. circuits (reg./not reg.) with add. heating with buffer

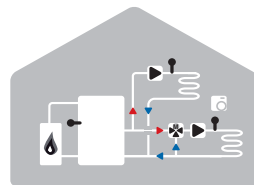

### 3.1 Wall installation



Caution

Install the controller only in dry areas and under the ambient conditions described under 2.1 „Specifications“. Carry out the following steps 1-8.

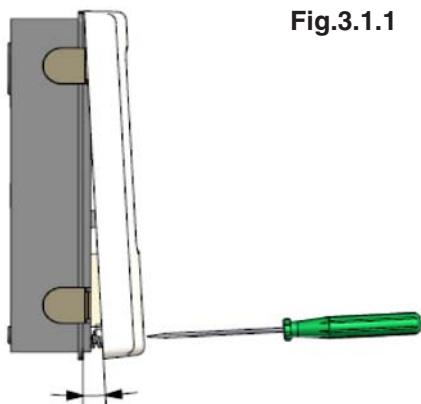
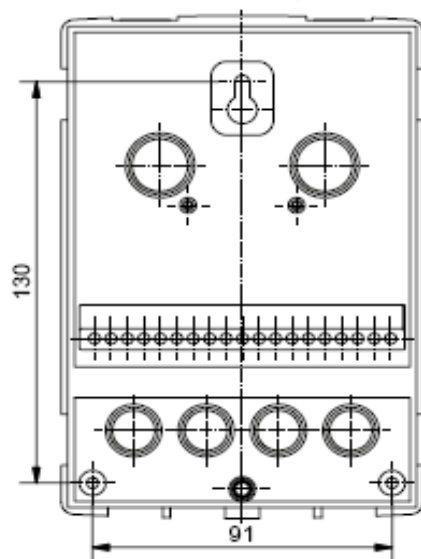
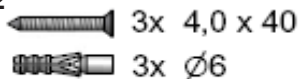

Fig.3.1.1

1. Unscrew cover screw completely
2. Carefully pull upper part of housing from lower part.
3. Set upper part of housing aside, being sure not to touch the electronics when doing so.
4. Hold the lower part of the housing up to the selected position and mark the 3 mounting holes. Make sure that the wall surface is as even as possible so that the housing does not become distorted when it is screwed on.

Fig.3.1.2



5. Using a drill and size 6 bit, drill 3 holes at the points marked on the wall and push in the plugs.
6. Insert the upper screw and screw it in slightly.
7. Fit the upper part of the housing and insert the other two screws.
8. Align the housing and tighten the three screws.



Caution

For panel installation, a special installation set is available as an accessory.

### 3.2 Electrical connection



**Danger**

Before working on the unit, switch off the power supply and secure it against being switched on again!

Check for the absence of power!

Electrical connections may only be made by a specialist and in compliance with the applicable regulations. The controller may not be put into operation if there is visible damage to the housing, e.g. cracks.



**Caution**

Low-voltage cables such as temperature sensor cables must be routed separately from mains voltage cables. Feed temperature sensor cables only into the left-hand side of the unit, and mains voltage cables only into the right-hand side.



**Caution**

The customer must provide an all-pole disconnecting device, e.g. a heating emergency switch.



**Caution**

The cables being connected to the unit must not be stripped by more than 55mm, and the cable jacket must reach into the housing just to the other side of the strain relief.

**Fig.  
3.2.1**

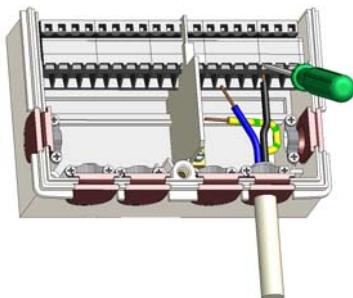

1. Open controller housing (see 3.1)

2. Strip cables max. 55mm, insert, fit the strain relief devices, strip the last 8-9 mm of the wires. (Fig.3.2.1)

3. Open the terminals using a suitable screwdriver (Fig. 3.2.1) and make electrical connections on the controller (Pages 10)

4. Refit upper part of housing and fasten with screw.

6. Switch on mains voltage and place controller in operation

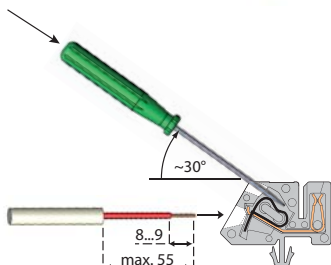

### 3.2.2 Electrical terminals



Caution

Left-hand terminal compartment only for low voltage if max. 12VAC/DC

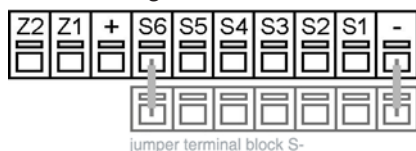

Danger

Right-hand terminal compartment only for mains voltages of 115VAC 50-60Hz



Connections low voltage:

- Temperature sensors S1 - S6 (polarity freely selectable)
- Optional additional functions Z1/Z2

**Low voltage** max. 12VAC/DC connection in the left-hand terminal compartment!

<u>Terminal:</u>	<u>Connection for:</u>
-	Jumper terminal block S-
S1	outdoor
S2	heating circuit
S3	heating circuit 2
S4	buffer
S5	indoor sensor
S6	remote adjuster*
+	not used
Z1	Option / add. function
Z2	Option / add. function

Use terminal block S- for connecting the sensor earths of S1-S6. The polarity of the sensors is freely selectable.

The sensors S3-S6 are optional, depending on the hydraulic variant chosen.

Connections Mains Voltage:

- Protective conductor PE metal terminal block
  - Neutral conductor terminal block N
  - Mains phase conductor L
  - Switch output R1-R4
  - Floating contact at R5/R5I
- Caution: Only suitable for 115V!

**Mains Voltage** 115VAC 50-60Hz connection in the right-hand terminal compartment.

<u>Terminal:</u>	<u>Connection for:</u>
N	Jumper terminal block N
L	Mains phase conductor L
R1	Heat circuit pump
R2	Mixer open
R3	Mixer close
R4	Heat circuit pump (HC2)
R5	add. heating
R5I	add. heating

The PE protective conductor must be connected to the PE metal terminal block!

\* Note: If the remote adjuster RC21 or a different external floating thermostat is connected, the bridge at S6 has to be removed.

### 3.3 Installing the temperature sensors

The controller operates with Pt1000 temperature sensors which are accurate to the degree, thus ensuring optimal control of system functions.



Caution

If desired the sensor cables can be extended to a maximum of 30m using a cable with a cross-section of at least 0.75mm<sup>2</sup>. Make sure that there is no contact resistance!

Position the sensor precisely in the area to be measured!

Only use immersion, pipe-mounted or fl at-mounted sensor suitable for the specific area of application with the appropriate permissible temperature range.



Caution

The temperature sensor cables must be routed separately from mains voltage cables, and must not, for example, be routed in the same cable duct!



Caution

S6 is by default connected by jumper with the terminal block S- to enable the heating circuit functions. If the jumper is removed, the heating circuit is switched off. When connecting the remote adjuster RC21 the jumper has to be removed. If a third party external thermostat is connected, it's electrical contacts has to be floating and of low resistance = 0 Ohm.



Caution

Connect sensor S3 in an optional 2nd heat circuit (see 2.5 diagrams 4, 5 and 6 on page 7)

The optional sensor 4 is used to switch off the additional heating at the buffer storage (see 10.9 Reference/actual+, page 23).

### 3.4 Installation of the additional functions via clamps Z1/Z2



Caution

The instructions are supplied with the expansion board. The installation has to be commenced accordingly and all warnings have to be observed.

### 4.1 Display and input

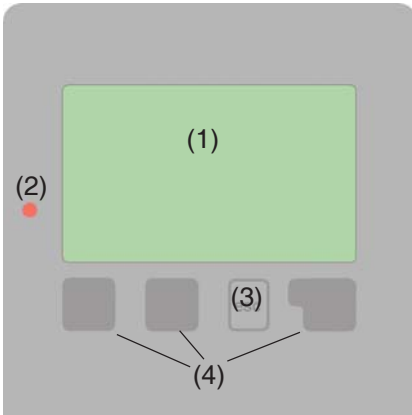

The display (1), with its extensive text and graphics mode, is almost self-explanatory, allowing easy operation of the controller.















The LED (2) lights up green when a relay is switched on.

The LED (2) lights up red when operating mode „Off“ is set.

The LED (2) flashes slowly red in the operating mode „Manual“.

The LED (2) flashes quickly red when an error is present.

Examples of display symbols:

-  Heating circuit pump  
(rotates when active)
-  Heating circuit mixer  
(black when active)
-  HC -Day mode (Time progr.)
-  HC-Night mode (Time progr.)
-  HC-Comfort mode (Time progr.)
-  Day mode
-  Night mode
-  Day mode due to RC21
-  Night mode due to RC21
-  Additional heating
-  Reference value mode
-  Reference value 14 day
-  external thermostat off
-  Warning / Error message
-  New information available

Entries are made using four keys (3+4), to which different functions are assigned depending on the situation. The „esc“ key (3) is used to cancel an entry or to exit a menu. If applicable there will be a request for confirmation as to whether the changes which have been made should be saved.

The function of each of the other three keys (4) is shown in the display line directly above the keys; the right-hand key is generally has a confirmation and selection function.

Examples of key functions:

- +/- = enlarge/shrink values
- ▼/▲ = scroll menu down/up
- yes/no = approve/reject
- Info = additional information
- Back = to previous screen
- ok = confirm selection
- Confirm = confirm setting

### 4.2 Menu sequence and menu structure

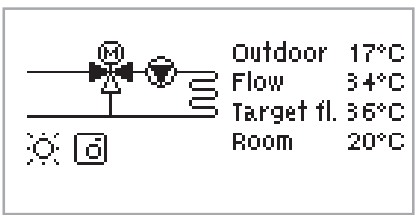

The graphics or overview mode appears when no key has been pressed for 2 minutes, or when the main menu is exited by pressing „esc“.

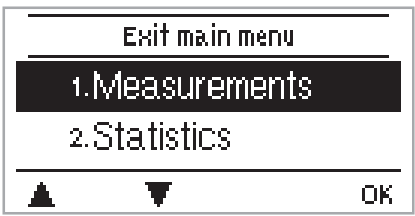

Pressing a key in graphics or overview mode takes you directly to the main menu. The following menu items are then available for selection there:



1. Measurements	Current temperature values with explanations (see 6.)
2. Statistics	Function control of the system with operating hours, etc. (see 7.)
3. Times	Operating times for heating circuit and hot water, setting the clock (see 8.)
4. Operating mode	Operating times for heating circuit and hot water, manual mode (see 9.)
5. HC settings	Set parameters for the heating circuit (see 10.)
6. HC2 settings	Set parameters for the 2nd heating circuit (see 11.)
7. Protections	Anti-seizing protection, Frost prot., Anti-Legionella activation (see 12.)
8. Special functions	Sensor calibration, Remote adjuster, Mixer, etc. (see 13.)
9. Menu lock	Against unintentional setting changes at critical points (see 14.)
10. Service Data	For diagnosis in the event of an error (see 15.)
11. Language	Selection of the menu language (see 16.)

### 5.1 Commissioning help



The first time the controller is turned on and after the language and time are set, a query appears as to whether you want to parametrise the controller using the commissioning help or not. The commissioning help can also be terminated or called up again at any time in the special functions menu. The commissioning help guides you through the necessary

basic settings in the correct order, and provides brief descriptions of each parameter in the display. Pressing the „esc“ key takes you back to the previous value so you can look at the selected setting again or adjust it if desired. Pressing the „esc“ more than once takes you back step by step to the selection mode, thus cancelling the commissioning help. Finally, menu 4.3 under operating mode „Manual“ should be used to test the switch outputs with the consumers connected, and to check the sensor values for plausibility. Then switch on automatic mode.



Caution

Observe the explanations for the the individual parameters on the following pages, and check whether further settings are necessary for your application.



Caution

The settings for the 2nd heating circuit are not made in the wizard. Activate the 2nd heat circuit by setting „Protections“ -“Max. flow2“

### 5.2 Free commissioning

If you decide not to use the commissioning help, you should make the necessary settings in the following sequence:

- Menu 10. Language (see 15.)
- Menu 3. Time, date and operating times (see 8.)
- Menu 5 Settings for heat circuit, all settings (see 10.)
- Menü 6. Protective functions if necessary (see 11.)
- Menü 7. Special functions if necessary (see 13.)

Finally, menu 4.2 under operating mode „Manual“ should be used to test the switch outputs with the consumers connected, and to check the sensor values for plausibility. Then switch on automatic mode.



Caution

Observe the explanations for the the individual parameters on the following pages, and check whether further settings are necessary for your application.

## 6. Measurement values

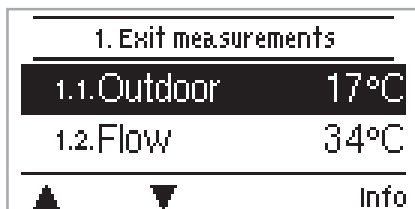

Menu “1. Measurement values” serves to display the currently measured temperatures.

The menu is closed by pressing “esc” or selecting “Exit measurement values”.

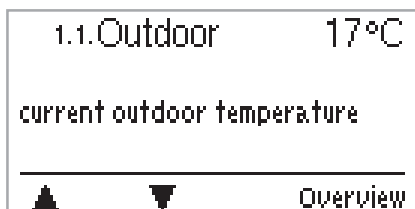

Selecting “Info” leads to a brief help text explaining the measurement values.

Selecting “Overview” or “esc” exits the Info mode.



### Caution

If “Error” appears on the display instead of the measurement value, then there may be a defective or incorrect temperature sensor.

If the cables are too long or the sensors are not placed optimally, the result may be small deviations in the measurement values. In this case the display values can be compensated for by making entries on the controller. Follow the instructions under 12.1.

What measurement values are displayed depends on the selected program, the connected sensors and the specific device design.

## 7. Statistics

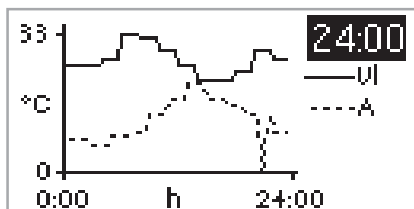

Menu “2. Statistics” is used for function control and long-term monitoring of the system.

The submenus described under 7.1-7.5 are available.

The menu is closed by pressing “esc” or selecting “Exit statistics”.



For system data statistics it is essential for the time to be set accurately on the controller. Please note that the clock continues to run for about 24 hours if the mains voltage is interrupted, and after that has to be reset. Improper operation or an incorrect time may result in data being cleared, recorded incorrectly or overwritten.

The manufacturer accepts no liability for the recorded data!

### 7.1 Today Menu 2.1 (=Flow temperature for the present day)

In the graphical overview the characteristics of outdoor-and flow temperature for the present day is shown from 0-24h. The right button changes the unit of time and the two left buttons scroll through the diagram.

### 7.2 28-days Menu 2.2 (=Flow temperature during the last 28 days)

In the graphical overview the characteristics of the outdoor and flow temperature during the last 28 days is shown. The right button changes the unit of time (Days) and the two left buttons scroll through the diagram.

### 7.3 Operating hours Heat Circuit Menu 2.3

Display of operating hours of the heat pump connected to the controller, and the date the measurement started.

### 7.4 Operating hours Heat Circuit 2 Menu 2.4

Display of operating hours of the 2nd heat pump connected to the controller, and the date the measurement started.

### 7.4 Operating hours heating Menu 2.5

Display of operating hours of additional heating, and the date the measurement started.

### 7.4 Error messages Menu 2.4

Display of the last three errors in the system with indication of date and time.

### 7.5 Reset / clear Menu 2.5

Resetting and clearing the individual statistics. Selecting “All statistics” clears everything except for the error log.

## 8. Times

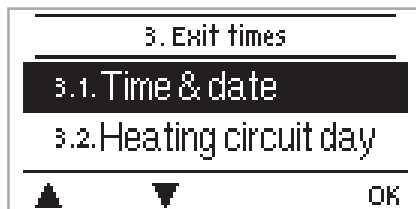

Menu “3. Times” is used to set the time, date, operating times for the heating circuit and hot water.



Caution

The associated temperature reference values are specified in menu 5 “Settings”!

The menu is closed by pressing “esc” or selecting “Exit display mode”.



### 8.1 Time & Date Menu 3.1

This menu is used to set the current time and date.



Caution

For proper functioning of the controller and statistics for the system data it is essential for the time to be set accurately on the controller. Please note that the clock continues to run for about 24 hours if the mains voltage is interrupted, and after that has to be reset.

### 8.2 Heating circuit day Menu 3.2

This menu is used to select the daytime mode times for the heating circuit; three time periods can be specified for each weekday and copied over to the following days.

*Setting range: Three time ranges for each day of the week*

*Default: Mo-Su 6:00-22:00*

*Note: See 10. for the associated temperature settings*



Caution

Times that are not specified are automatically considered to be nighttime mode. The set times are only taken into account in the heating circuit operating mode “Automatic”

### 8.3 Heating comfort Menu 3.3

This menu can be used to select a time range for each day of the week in which the heating circuit is supplied with an increased comfort temperature, e.g. for quick heating in the morning.

*Setting range: One time range for each day of the week*

*Default: Mo-Su off*

*Note: See 10. for the associated temperature settings.*

## 9. Operating modes

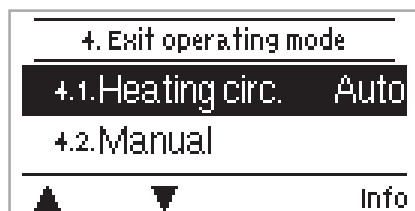

Menu “4. Operating modes” is used to specify the operating modes for the heating circuit.

After an interruption of the mains voltage the controller automatically returns to the last operating mode selected!

The menu is closed by pressing “esc” or selecting “Exit operating modes”.



Caution

The controller works with the set operating times and the corresponding different reference flow temperature values only in the automatic mode.

### 9.1 Heat circuit Menu 4.1

**Auto** = Automatic/Normal mode using the set times.

**Continuous Day** = The set values for day mode are used.

**Continuous Night** = The set values for night mode are used.

**Reference Value** = Fixed flow temperature regardless of the outdoor temperature. The desired flow temperature has to be set in menu 4.3.

**14 day reference value** = Specific fixed flow temperatures can be set for the next 14 days in menu 4.4. After 14 days, the reference temperature of the 14th day is used until the operating mode is changed.

**Off** = Heating circuit is switched off (except Frost protection)

*Settings range: Auto, Continuous day, Continuous night, Reference value, 14 day reference, Off*

*Default: Automatic*

## 9. Operating modes (continued)

### 9.3 Manual Menu 4.2

In Manual mode the individual relay outputs and the connected consumers can be checked for proper functioning and correct assignment.



**Danger**

The operating mode “Manual” may only be used by specialists for brief function tests, e.g. during commissioning!

Function in manual mode:

The relays and thus the connected consumer are switched on and off by pressing a key, with no regard to the current temperatures and the parameters which have been set. At the same time, the current measurement values of temperature sensors are also shown in the display for the purposes of function control.

### 9.3 Heat circuit reference Menu 4.3

If operating mode “Reference value” is selected, (Menu 4.1), the reference flow temperature has to be set here, regardless of the curve/outdoor temperature.

*Settings range: 10 °C to 75 °C*

*Default: 30 °C*

### 9.4 14 day reference Menu 4.4

If operating mode “14 day reference value” is selected (Menu 4.1), the reference flow temperature for each of the 14 days can be set here.

In the first menu 4.4.1 the starting time of the program is shown. To start the program, hit restart.

Hitting “restart” again will reset the 14 day reference program and start it at day 1.

## 10. Settings HC

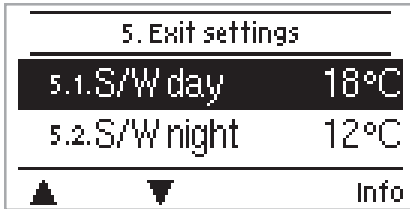

The necessary basic settings required for the control function of the heating circuit are made in menu "5. Settings HC".



**Caution**

This does not under any circumstances replace the safety facilities to be provided by the customer!

The menu is closed by pressing "esc" or selecting "Exit settings".

### 10.1 Su/Wi Day Menu 5.1 = Summer/Winter changeover in daytime mode

If this value is exceeded at outdoor sensor S1 during the daytime mode times, the controller automatically switches the heating circuit off = Summer mode.

If the outdoor temperature drops below this value, the heating circuit is switched on again = Winter mode.

*Setting range: from 0°C to 30°C / default setting: 18°C*



**Caution**

In addition to the operating times in normal daytime operation, this setting is also valid for times with activated comfort temperature boost and activated low-rate period boost.

### 10.2 Su/Wi Night Menu 5.2 = Summer/Winterchangeover in nighttime mode

If this value is exceeded at outdoor sensor S1 during the nighttime mode times, the controller automatically switches the heating circuit off = Summer mode.

If the outdoor temperature drops below this value, the heating circuit is switched on again = Winter mode.

*Settings range: 0°C to 30°C / Default: 12°C*

## 10. Settings HC (continued)

### 10.3 Curve Menu 5.3 = Slope of the characteristic heating curve

The characteristic curve is used to control the heat dissipation of the heating circuit relative to the outdoor temperature.

The demand for heat is different due to differences in the type of building/insulation/type of heating/outdoor temperature. For this reason the controller can make use of a normal straight curve (Setting simple) or a split curve (Setting split).

In the simple setting the curve can be adjusted with the help of the graphic diagram. The slope is changed, and the calculated reference flow temperature is displayed for  $-12^{\circ}\text{C}$ .

If the split mode is selected, the characteristic curve is adjusted in 3 steps. First the standard slope has to be set, after that the split point and finally the steepness of the curve after the split. While adjusting the curve the steepness of the slope and the calculated reference flow temperature for  $-12^{\circ}\text{C}$  outdoor temperature is displayed.

*Settings range:*

*Characteristic curve : simple or split / Default: simple*

*Slope : 0.0...3.0 / Default: 0.8*

*Splitpoint at outdoor temp.:  $+10^{\circ}\text{C}$ ... $-10^{\circ}\text{C}$*

*Angle: differs, depends on steepnes and split point*

The diagram shows the influence of the selected characteristic curve steepness (standard curve) on the calculated reference flow temperature of the heating circuit. The correct curve is appointed by setting the intersection point of the calculated maximum flow temperature and the minimum outdoor temperature.

Example:

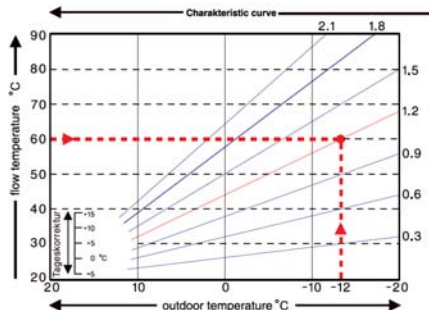

Maximum calculated flow temperature  $60^{\circ}\text{C}$  at minimum outdoor temperature according to heat demand calculation  $-12^{\circ}\text{C}$ .

The intersection results in a slope of 1.2.

## 10. Settings HC (continued)



Caution

The following settings can be used for parallel translation of the characteristic for certain time periods such as daytime and nighttime mode.

### 10.4 Day correction Menu 5.4 = parallel translation of the characteristic

The day correction produces a parallel translation of the heating characteristic during the daytime operating hours, since depending on the outdoor temperature it is possible that the building may not be optimally heated with the set characteristic. If the characteristic is not optimised, the following situation may occur:

in hot weather - the spaces are too cold

in cold weather - the spaces are too hot

In this case, one should gradually reduce the characteristic slope in steps of 0.2, each time raising the day correction by 2-4 °C.

This procedure can be repeated several times as needed.

*Setting range: from -10°C to 50°C / default setting: 5*

### 10.5 Night correction Menu 5.5 = parallel translation of the characteristic

The night correction produces a parallel translation of the heating characteristic during the nighttime operating hours. If a negative value is set for the night correction, the reference flow temperature is lowered accordingly during the nighttime operating hours. In this manner, primarily at night, but also during the day when no-one is at home, the room temperature is lowered, thus saving energy.

Example: A day correction of +5°C and a night correction of -2°C produces a reference flow temperature in nighttime operation that is 7°C lower.

*Setting range: from -30°C to 30°C / default setting: -2°C*

### 10.6 Comfort temperature boost Menu 5.6 = parallel translation of the characteristic

The comfort temperature boost is added to the set day correction. In this manner it is possible to carry out quick heating and/or a higher temperature in the living spaces at a certain time each day.

*Setting range: from 0°C to 15°C / default setting: 0°C = off*

## 10. Settings HC (continued)

**10.8 Reference/actual - Menu 5.8** = Switch on hysteresis for additional heating  
This setting determines the allowed undershoot of the heat circuit temperature under the calculated reference flow temperature. If the heat circuit flow temperature falls below the reference temperature by this value, the additional heating (R5) is activated after a delay of 5 minutes.  
*Settings range: -10°C to 10°C / Default: -2°C*



The additional heating (relais R5) is started when the flow temperature (in case of 2 heat circuits: one of the flow temperatures) is below the reference flow temperature for 5 minutes continuously.

**10.9 Reference/actual + Menu 5.9** = Switch off hysteresis (only if S4 is connected)  
This settings determines the allowed overstepping of the heat circuit temperature to the calculated reference flow temperature at sensor 4. If the temperature at S4 exceeds the reference flow temperature by this value, the additional heating (R5) is switched off.  
*Settings range: 1°C to 10°C / Default: 2°C*



Caution

If sensor 4 is not connected, the additional heating at R5 is switched off when the sensor of the heat circuit S2 (respectively, of the heat circuits S2 and S3) reaches or exceeds the reference flow temperature.



Caution

It is recommended to install sensor 4 in the buffer at the same level (or below) of the heat circuit conduit to prevent unnecessary switching of the additional heating.

## 11. Settings HC 2

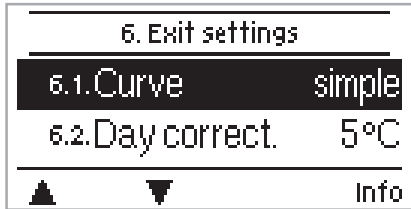

The necessary basic settings required for the control function of the 2nd heating circuit are made in menu “6. Settings HC 2”.



Caution

This does not under any circumstances replace the safety facilities to be provided by the customer!

The menu is closed by pressing “esc” or selecting “Exit settings”.



The settings for Su/Wi Day, Su/Wi Night, Reference/actual- and Reference/actual+, which are made in “Settings heat circuit” are applied to both heating circuits

### 11.1 Curve Menu 6.1 = Slope of the characteristic heating curve

The characteristic curve is used to control the heat dissipation of the heating circuit relative to the outdoor temperature.

The demand for heat is different due to differences in the type of building/insulation/type of heating/outdoor temperature. For this reason the controller can make use of a normal straight curve (Setting simple) or a split curve (Setting split).

In the simple setting the curve can be adjusted with the help of the graphic diagram. The slope is changed, and the calculated reference flow temperature is displayed for -12 °C.

If the split mode is selected, the characteristic curve is adjusted in 3 steps. First the standard slope has to be set, after that the split point and finally the steepness of the curve after the split. While adjusting the curve the steepness of the slope and the calculated reference flow temperature for -12 °C outdoor temperature is displayed.

*Settings range:*

*Characteristic curve : simple or split / Default: simple*

*Slope : 0.0...3.0 / Default: 0.8*

*Splitpoint at outdoor temp.: +10°C...-10°C*

*Angle: differs, depends on steepnes and split point*

### 11. Settings HC (continued)



Caution

The following settings can be used for parallel translation of the characteristic for certain time periods such as daytime and nighttime mode.

#### 11.2 Day correction Menu 6.2 = parallel translation of the characteristic

The day correction produces a parallel translation of the heating characteristic during the daytime operating hours, since depending on the outdoor temperature it is possible that the building may not be optimally heated with the set characteristic. If the characteristic is not optimised, the following situation may occur:

in hot weather - the spaces are too cold

in cold weather - the spaces are too hot

In this case, one should gradually reduce the characteristic slope in steps of 0.2, each time raising the day correction by 2-4 °C.

This procedure can be repeated several times as needed.

*Setting range: from -10°C to 50°C / default setting: 5*

#### 11.3 Night correction Menu 6.3 = parallel translation of the characteristic

The night correction produces a parallel translation of the heating characteristic during the nighttime operating hours. If a negative value is set for the night correction, the reference flow temperature is lowered accordingly during the nighttime operating hours. In this manner, primarily at night, but also during the day when no-one is at home, the room temperature is lowered, thus saving energy.

Example: A day correction of +5°C and a night correction of -2°C produces a reference flow temperature in nighttime operation that is 7°C lower.

*Setting range: from -30°C to 30°C / default setting: -2°C*

#### 11.4 Comfort temperature boost Menu 6.4 = parallel translation of the characteristic

The comfort temperature boost is added to the set day correction. In this manner it is possible to carry out quick heating and/or a higher temperature in the living spaces at a certain time each day.

*Setting range: from 0°C to 15°C / default setting: 0°C = off*

## 12. Protective functions

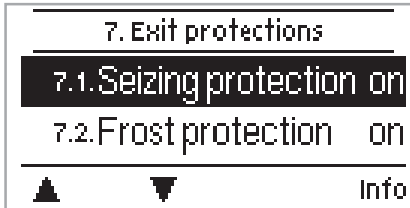

Menu “7. Protective functions” can be used by specialists to activate and set various protective functions.



Caution

This does not under any circumstances replace the safety facilities to be provided by the customer!

The menu is closed by pressing “esc” or selecting “Exit settings”.



### 12.1 Anti-seizing protection Menu 7.1

If the anti-seizing protection is activated, the controller switches the heat pump and the mixer on/off at 12:00 pm for 5 seconds to prevent seizing of the pump/valve after long periods of inactivation.

*Settings range: on, off / Default: on*

### 12.2 Frost protection Menu 7.2

Frost protection function can be activated for the heat circuit. If the outdoor temperature at sensor S1 drops below 1 °C and the heat circuit is switched off, the controller switches the heat circuit back on with the reference temperature set in in menu 6.3 (min. flow temperature). As soon as the outdoor temperature exceeds 1°C the heat circuit is switched off again.

*Frost protection - settings range: on, off / Default: on*



Caution

Switching the frost protection function off or setting the minimum flow temperature too low can lead to severe damage of the system.

### 12.3 min. flow temperature Menu 7.3

The minimum flow temperature is the lower limit for the characteristic curve/slope and as a result of the reference flow temperature of the heat circuit. Additionally, the min. flow temperature is the reference flow temperature for the frost protection.

*Settings range: 5°C to 30°C / Default: 15°C*

**12. Protective functions** (continued)**12.4 max. flow Menu 7.4**

This is used as the upper limit for the reference flow temperature of the heat circuit. Should the heat circuit temperature exceed this value, the heat circuit is switched off until the temperature drops below.

*Settings range: 30 °C to 105 °C / Default: 45 °C*



For safety, the customer must provide an additional limiting thermostat which is connected to the pumps in series.

**12.5 max. flow Menu 7.5**

Set this to activate the 2nd heat circuit.

This is used as the upper limit for the reference flow temperature of the 2nd heat circuit. Should the heat circuit temperature exceed this value, the heat circuit is switched off until the temperature drops below.

*Settings range: Off, 30 °C to 105 °C / Default: 45 °C*



Set this to activate the 2nd heat circuit.

### 13. Special functions



Menu “8. Special functions” is used to set basic items and expanded functions.



The settings in this menu should only be made by a Caution specialist.



The menu is closed by pressing “esc” or selecting “Exit special functions”.

#### 13.1 Sensor calibration Menu 8.1 / 8.1.1 - 8.1.6

Deviations in the temperature values displayed, for example due to cables which are too long or sensors which are not positioned optimally, can be compensated for manually here. The settings can be made for each individual sensor in steps of 0.5°C.

*Offset S1...S6 per settings range : -10°C...+10°C Default : 0°C*



Settings are only necessary in special cases at the time of initial commissioning by the specialist. Incorrect measurement values can lead to unpredictable errors.

#### 13.2 Commissioning Menu 8.2

Starting the commissioning help guides you in the correct order through the basic settings necessary for commissioning, and provides brief descriptions of each parameter in the display.

Pressing the “esc” key takes you back to the previous value so you can look at the selected setting again or adjust it if desired. Pressing the “esc” more than once takes you back to the selection mode, thus cancelling the commissioning help. (see also 5.1)



May only be started by a specialist during commissioning! Observe the explanations for the individual parameters in these instructions, and check whether further settings are necessary for your application.

#### 13.3 Factory settings Menu 8.3

All of the settings that have been made can be reset, thus returning the controller to its delivery state.



The entire parametrisation, statistics, etc. of the controller will be lost irrevocably. The controller must then be commissioned once again.

### 13.4 Expansions Menu 8.4

This menu can only be selected and used if additional options or expansion modules have been built into the controller.

The associated supplementary installation, mounting and operation instructions are then included with the specific expansion.

### 13.5 Mixer Menu 8.5



Settings are only necessary at the time of initial commissioning by the specialist. Incorrect measurement values can lead to severe unpredictable errors.

#### 13.6 Turn time Menu 8.5.1

The mixer is switched on i.e. is opening or closing for the timespan set here, then the temperature is measured to control the flow temperature.

*Settings range: 0.5 sec to 3 sec. / Default: 2 sec.*

#### 13.7 Pause-Factor Menu 8.5.2

The calculated pause time of the mixer is multiplied with the value set here. If the pause factor is "1", the normal pause time is used, "0.5" will use half the normal pause time, "4" would quadruple the pause time.

*Settings range: 0.1 to 4.0 / Default: 1.0*

#### 13.8 Increase Menu 8.5.3

If the temperature rises very fast, this value is added to the measured flow temperature so that the mixer's reaction is stronger.

If the measured temperature does not rise any more, the measured value is used again. The measurement occurs once every minute.

*Settings range: 0 to 20 / Default: 8*

### 13.9 Room controller Menu 8.6

The settings necessary for the optional room controller RC21 are made in this menu.

The 3 modes “continuous day”, “continuous night” and “Time controlled/automatic” can be switched at the RC21.

Additionally the reference temperature of the flow can be parallel translated by turning the control wheel. If the wheel is set to minimum, only the minimum values that can be set in the protective functions menu will be used.



In the operating modes “Reference value” and “14day ref.” the remote adjuster is without function.

Caution

#### 13.9.1 Room controller Menu 8.6.1

This value is used to appoint the amount of influence in percent the room temperature has on the reference flow temperature. For every degree of deviation of the room temperature from the reference room temperature the percentage of the calculated reference flow temperature set here is added to or, respectively, subtracted from the reference flow temperature. As long as it is within the limits of the min. and max. flow temperatures that can be set in the protective functions.

Example: Reference roomtemp.: e.g. 25 °C ; room temp.: e.g. 20 °C = 5 °C deviation.

calculated reference temp.: e.g. 40 °C : room controller: 10 % = 4 °C

5 X 4 °C = 20 °C According to this 20 °C are added to the reference flow temperature, resulting in 60 °C. If the value is higher than the one set in max. flow temp., the resulting temperature is only the one set in max. flow temp.

*Settings range: 0 % to 20 % / Default: 0*

#### 13.9.2 Room reference day Menu 8.6.2

The desired room temperature for day mode. As long as this temperature is not reached, the reference flow temperature is raised or respectively lowered according to the percent setting in “room controller”. If “room controller” is set to 0%, this function is deactivated.

*Settings range: 10 °C to 30 °C / Default: 20 °C*

#### 13.9.3 Room reference night Menu 8.6.3

The desired room temperature for night mode. As long as this temperature is not reached, the reference flow temperature is raised or respectively lowered according to the percent setting in “room controller”. If “room controller” is set to 0%, this function is deactivated.

*Settings range: 10 °C to 30 °C / Default: 20 °C*

**14****Menu lock Menu 9****14****14. Menu lock**

Menu “9. Menu lock” can be used to secure the controller against unintentional changing and compromise of basic functions.

The menu is closed by pressing “esc” or selecting “Exit menu lock”.



The menus listed below remain completely accessible despite the menu lock being activated, and can be used to make adjustments if necessary:

1. Measurement values
2. Statistics
3. Times
8. Menu lock
9. Service values

To block the other menus, select “Menu lock on”.  
 To enable the menus again, select “Menu lock off”.  
*Setting range: on, off / default setting: off*

**15****Language Menu 11****15****15. Language**

Menu “11. Language” can be used to select the language for the menu guidance.

This is queried automatically during initial commissioning.

The choice of languages may differ, however, depending on the device design. Language selection is not available in every device design!



## 16. Service values

10.1.	HCC+ 2008/11/26.383+	
10.2.	Outdoor	0°C
10.3.	Flow	0°C



Menu “10. Service values” can be used for remote diagnosis by a specialist or the manufacturer in the event of an error, etc.



Enter the values at the time when the error occurs  
**Caution** into the table.

The menu can be closed at any time by pressing “esc”.

9.1		9.31		9.61	
9.2		9.32		9.62	
9.3		9.33		9.63	
9.4		9.34		9.64	
9.5		9.35		9.65	
9.6		9.36		9.66	
9.7		9.37		9.67	
9.8		9.38		9.68	
9.9		9.39		9.69	
9.10		9.40		9.70	
9.11		9.41		9.71	
9.12		9.42		9.72	
9.13		9.43		9.73	
9.14		9.44		9.74	
9.15		9.45		9.75	
9.16		9.46		9.76	
9.17		9.47		9.77	
9.18		9.48		9.78	
9.19		9.49		9.79	
9.20		9.50		9.80	
9.21		9.51		9.81	
9.22		9.52		9.82	
9.23		9.53		9.83	
9.24		9.54		9.84	
9.25		9.55		9.85	
9.26		9.56		9.86	
9.27		9.57		9.87	
9.28		9.58		9.88	
9.29		9.59		9.89	
9.30		9.60		9.90	

### 17.1 Malfunctions with error messages

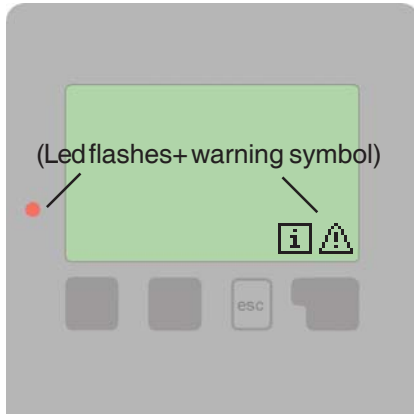

If the controller detects a malfunction, the red light flashes and the warning symbol also appears in the display. If the error is no longer present, the warning symbol changes to an info symbol and the red light no longer flashes. To obtain more detailed information on the error, press the key under the warning or info symbol.



**Danger**

Do not try to deal with this yourself. Consult a specialist in the event of an error!

Possible error/information messages:

Notes for the specialist:

Sensor x defective----->

Means that either the sensor, the sensor input at the controller or the connecting cable is/was defective. (Resistance table on page 5)

max. heat circuit----->  
(Information only)

The maximum heat circuit temperature set in menu 6.3 was exceeded.

Restart----->  
(Information only)

Means that the controller was restarted, for example due to a power failure. Check the date&time!

### 17.2 Replacing the fuse



**Danger**

Repairs and maintenance may only be performed by a specialist. Before working on the unit, switch off the power supply and secure it against being switched on again! Check for the absence of power!



**Danger**

Only use the supplied spare fuse or a fuse of the same design with the following specifications: T2A 250V

**Fig.3.1.1**

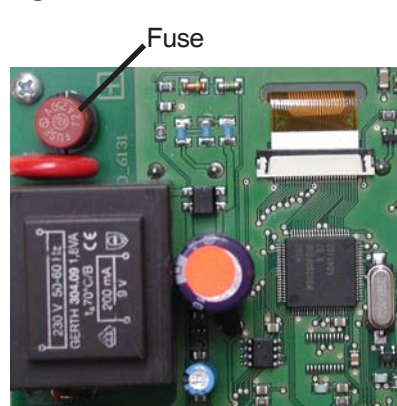

If the mains voltage is switched on and the controller still does not function or display anything, then the internal device fuse may be defective.

In that case, open the device as described under 3.1, remove the old fuse and check it.

Exchange the defective fuse for a new one, locate the external source of the error (e.g. pump) and exchange it. Then first recommission the controller and check the function of the switch outputs in manual mode as described under 9.3.

### 17.3. Maintenance



**Caution**

In the course of the general annual maintenance of your heating system you should also have the functions of the controller checked by a specialist and have the settings optimised if necessary.

Performing maintenance:

- Check the date and time (see 8.1)
- Assess/check plausibility of statistics (see 7.)
- Check the error memory (see 7.4)
- Verify/check plausibility of the current measurement values (see 6.)
- Check the switch outputs/consumers in manual mode (see 9.3)
- Poss. optimise the parameter settings



The service values (see 15.) include not only current measurement values and operating states, but also all of the settings for the controller. Write the service values down just once after commissioning has been successfully completed.



In the event of uncertainty as to the control response or malfunctions the service values are a proven and successful method for remote diagnosis. Write the service values down (see 15.) at the time that the suspected malfunction occurs. Send the service value table by fax or e-mail with a brief description of the error to the specialist or manufacturer.



To protect against loss of data, record any statistics and data that are particularly important to you (see 7.) at regular intervals.

---

Hydraulic variant set:

Commissioned on:

Commissioned by:

---

Final declaration:

Although these instructions have been created with the greatest possible care, the possibility of incorrect or incomplete information cannot be excluded. Subject as a basic principle to errors and technical changes.

---

Manufacturer: SOREL GmbH Mikroelektronik Jahnstr. 36 D - 45549 Sprockhövel Tel. +49 (0)2339 6024 Fax +49 (0)2339 6025 www.sorel.de info@sorel.de	Your specialist dealer:
--	-------------------------