

Fresh water controller FWC 5

Installation and operating instructions

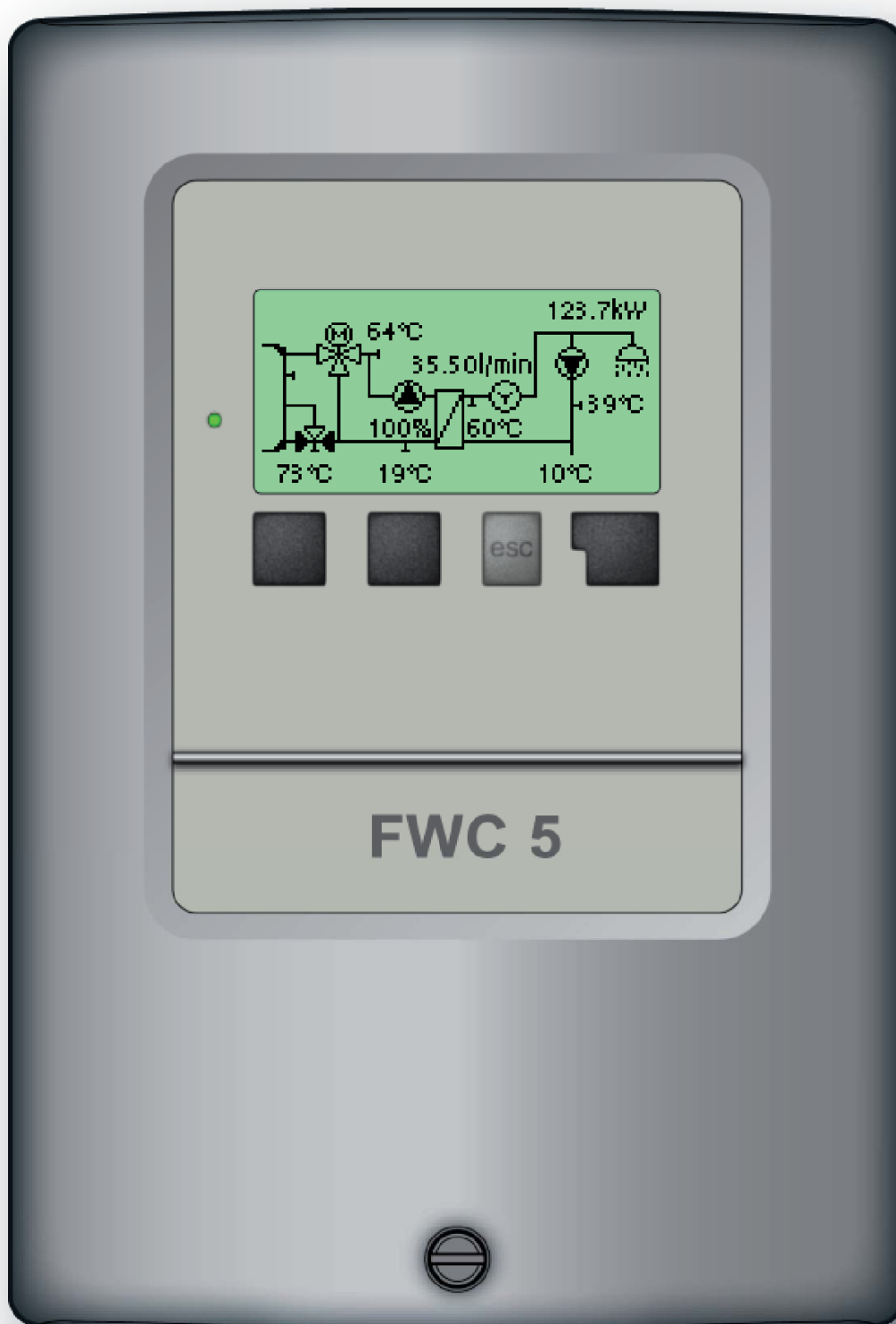

Read carefully before installation, commissioning and operation

Content

	page		page
A.1 EC declaration of conformity	3	5. Settings	19
A.2 General instructions	3	5.1 Tsetpoint	19
A.3 Explanation of symbols	3	5.2 Tmax	19
A.4 Changes to the unit	4	5.3 Primary flow	19
A.5 Warranty and liability	4	5.4 Cold water	19
		5.5 VFS-Type	20
B.1 Specifications	5	5.6 Comfort	20
B.2 Temperature resistance table for Pt1000 sensors	5	5.7 Circulation	20
B.2 About the controller	6	5.8 Purging time	20
B.3 Scope of supply	6	5.9 Circulation pause time	20
B.4 Disposal and pollutants	6	5.10 Cirk. Tmin.	21
B.5 Hydraulic variants	7	5.11 Circ. hysteresis	21
		5.12 Circulation period	21
C.1 Wall installation	8	6. Special functions	22
C.2 Electrical connection	9	6.1 Time & Date	22
C.3 Installing the temperature sensors	10	6.2 Sensor calibration	22
		6.3 Commissioning	22
D Terminal connection diagram	11	6.4 Factory settings	23
		6.5 Mixer	23
E.1 Display and input	12	6.6 Antilegionella	24
E.2 Commissioning help	13	6.7 Speed control	25
E.3 Free commissioning	13	6.8 Limescale protection	25
E.4 Menu sequence and menu structure	14		
1. Measurement values	15	7. Menu Lock	26
2. Statistics	16	8. Service values	27
2.2 Operating hours circ.	16	9. Language	28
2.3 Heat output	16		
2.4 Graphic overview	16	Z.1 Malfunctions with error messages	29
2.5 Message log	16	Z.2. Replacing the fuse	30
2.6 Reset/clear	16	Z.3. Maintenance	30
3. Display mode	17		
3.1 Schematic	17		
3.2 Overview	17		
3.3 Alternating	17		
4. Operating modes	18		
4.1 Automatic	18		
4.2 Manual	18		
4.3 Off	18		

Safety instructions

A.1 EC declaration of conformity

By affixing the CE mark to the unit the manufacturer declares that the FWC conforms to the following relevant safety regulations:

- EC low voltage directive
73/23/EEC, as amended by 93/68/EEC
- EC electromagnetic compatibility directive
89/336/EEC version 92/31/EEC version 93/68/EEC

Conformity has been verified and the corresponding documentation and the EC declaration of conformity are kept on file by the manufacturer.

A.2 General instructions

It is essential that you read this!

These installation and operating instructions contain basic instructions and important information regarding safety, installation, commissioning, maintenance and the optimal use of the unit. Therefore these instructions must be read completely and understood by the installation technician/ specialist and by the system user before installation, commissioning and operation of the unit. The valid accident prevention regulations, VDE regulations, the regulations of the local power utility, the applicable DIN-EN standards and the installation and operating instruction of the additional system components must also be observed. The controller does not under any circumstances replace any safety devices to be provided by the customer! Installation, electrical connection, commissioning and maintenance of the unit may only be carried out by specialists who possess the appropriate training.

For the user: Make sure that the specialist gives you detailed information on the function and operation of the controller. Always keep these instructions in the vicinity of the controller.

A.3 Explanation of symbols



Failure to observe these instructions can result in danger to life from electric voltage.



Failure to observe these instructions can result in serious damage to health such as scalding, or even life-threatening injuries.



Failure to observe these instructions can result in destruction of the unit or the system, or damage to the environment.



Information which is especially important for the function and optimal use of the unit and the system.

Safety instructions

A.4 Changes to the unit



Changes to the unit can compromise the safety and function of the unit or the entire system.

- Changes, additions to or conversion of the unit are not permitted without the written permission from the manufacturer
- It is likewise forbidden to install additional components that have not been tested together with the unit
- If it becomes clear that safe operation of the unit is no longer possible, for example because of damage to the housing, then turn the controller off immediately
- Any parts of the unit or accessories that are not in perfect condition must be exchanged immediately
- Use only original spare parts and accessories from the manufacturer.
- Markings made on the unit at the factory must not be altered, removed or made illegible
- Only the settings actually described in these instructions may be made on the controller

A.5 Warranty and liability

The controller has been manufactured and tested with regard to high quality and safety requirements. The unit is subject to the statutory guarantee period of two years from the date of sale.

The warranty and liability shall not include, however, any injury to persons or material damage that is attributable to one or more of the following causes:

- Failure to observe these installation and operating instructions
- Improper installation, commissioning, maintenance and operation
- Improperly executed repairs
- Unauthorised structural changes to the unit
- Installation of additional components that have not been tested together with the unit
- Any damage resulting from continued use of the unit despite an obvious defect
- Failure to use original spare parts and accessories
- Use of the device for other than its intended purpose
- Operation above or below the limit values listed in the specifications
- Force majeure

Description of controller

B.1 Specifications

Electrical specifications:

Mains voltage	230VAC +/- 10%
Mains frequency	50...60Hz
Power consumption	2VA
Switched power	
overall	460VA (Outputs 1-4)
per relay	460VA for AC1 / 185W for AC3
speed control	0-10V output, internal resistor 10kΩ
Internal Fuse	2A slow-blow 250V
Protection category	IP40/II
Sensor inputs	4 x Pt1000 + 1x Vortex Flow Sensor (VFS)

Permissible ambient conditions:

Ambient temperature	
for controller operation	0°C...40°C
for transport/storage	0°C...60°C
Air humidity	
for controller operation	max. 85% rel. humidity at 25°C
for transport/storage	no moisture condensation permitted

Other specifications and dimensions

Housing design	2-part, ABS plastic
Installation methods	Wall installation, optionally panel installation
Overall dimensions	163mm x 110mm x 52mm
Aperture installation dimensions	157mm x 106mm x 31mm
Display	Fully graphical display 128 x 64 dots
Light diode	Multicolour
Operation	4 entry keys

Temperature sensors: (may not be included in the scope of supply)

immersion sensor	Pt1000, e.g. TT/P4 up to 95°C
pipe-mounted sensor	Pt1000, e.g. TR/P4 up to 95°C
Vortex Flow Sensor	flow and temperature measuring
Sensor leads	2x0.75mm ² extendable to max. 30m
Vortex Flow Sensor leads :	extendable up to 3 m

B.2 Temperature resistance table for Pt1000 sensors

°C	0	10	20	30	40	50	60	70	80	90	100
Ω	1000	1039	1077	1116	1155	1194	1232	1270	1308	1347	1385

Description of controller

B.2 About the controller

The Fresh water controller FWC5 facilitates efficient use and function control of your fresh water system. The device is impressive most of all for its functionality and simple, almost self-explanatory operation. For each step in the input process the individual entry keys are assigned to appropriate functions and explained. The controller menu contains headwords for the measured values and settings, as well as help texts or clearly-structured graphics.

Important characteristics of the FWC5:

- 0-10V output for speed control
- Simple viewing of the current measurement values
- Analysis and monitoring of the system by means of statistical graphics, etc.
- Extensive setting menus with explanations
- Menu block can be activated to prevent unintentional setting changes
- Resetting to previously selected values or factory settings

B.3 Scope of supply

- Fresh water controller FWC
- replacement fuse 2A slow-blow
- Installation and operating instructions FWC

Optionally contained depending on design/order:

- Pt1000 temperature sensor and Vortex Flow Sensor (TFS)

B.4 Disposal and pollutants

The unit conforms to the European RoHS directive 2002/95/EC for the restriction of the use of certain hazardous substances in electrical and electronic equipment.



The unit must not under any circumstances be disposed of with ordinary household refuse. Dispose of the unit only at appropriate collection points or ship it back to the seller or manufacturer.

Description of controller

B.5 Hydraulic variants

2.5 Hydraulic variants



The following illustration should be viewed only as schematic diagram showing the hydraulic system, and does not claim to be complete. The controller does not replace safety devices under any circumstances. Depending on the specific application, additional system components and safety components may be mandatory, such as check valves, non-return valves, safety temperature limiters, scalding protectors, etc., and must therefore be provided.

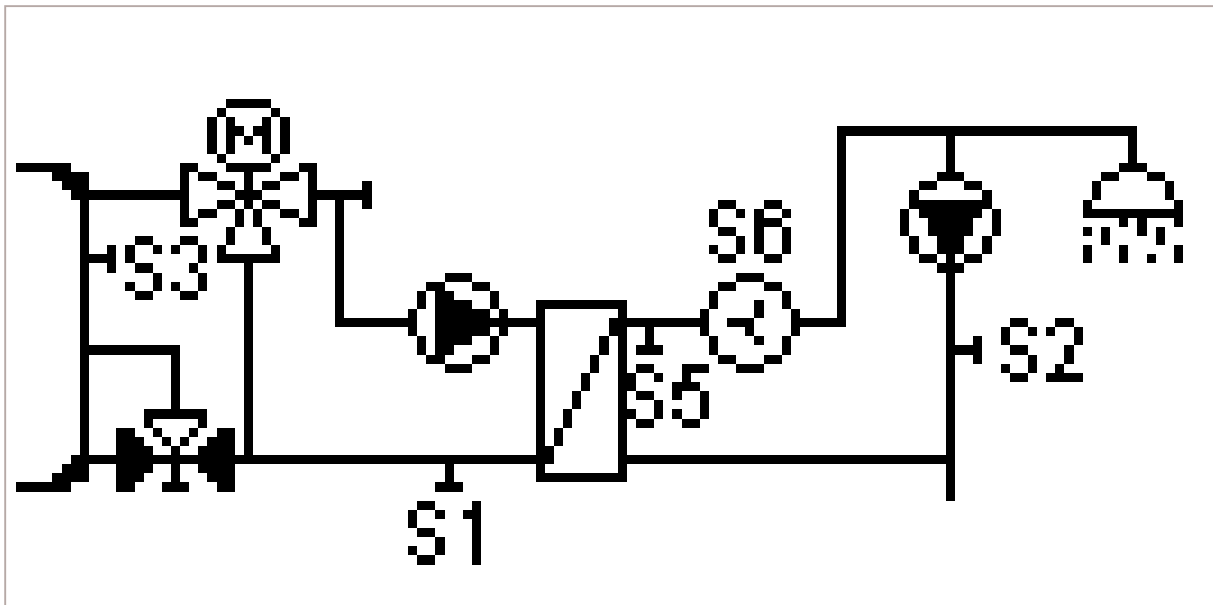

Installation

C.1 Wall installation



Install the controller only in dry areas and under the ambient conditions described under B.1 "Specifications". Carry out the following steps 1-8.

C.1.1

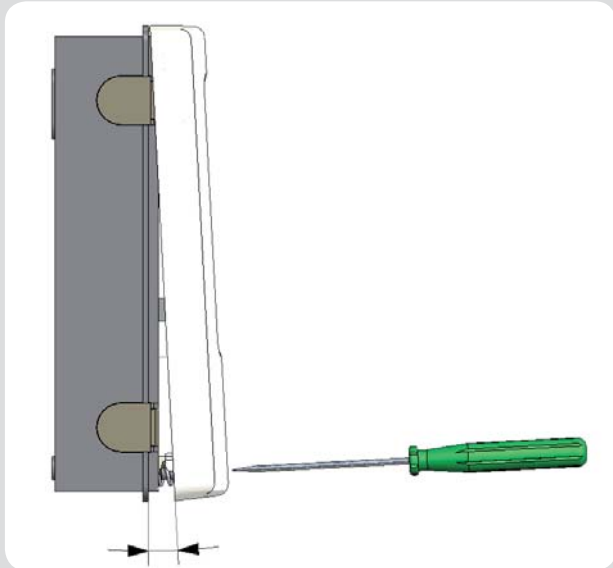

1. Unscrew cover screw completely
2. Carefully pull upper part of housing from lower part.
3. Set upper part of housing aside, being sure not to touch the electronics when doing so.
4. Hold the lower part of the housing up to the selected position and mark the 3 mounting holes. Make sure that the wall surface is as even as possible so that the housing does not become distorted when it is screwed on.

C.1.2

 3x 3,5 x 30

 3x Ø6

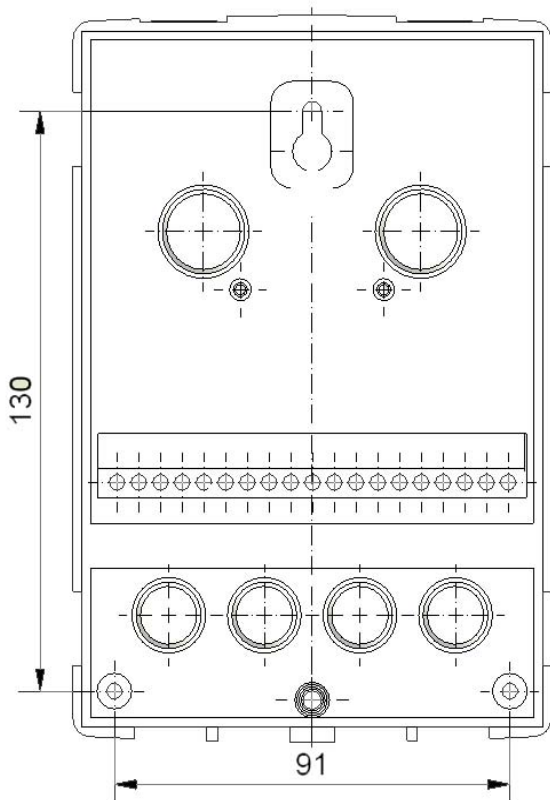

5. Using a drill and size 6 bit, drill 3 holes at the points marked on the wall and push in the plugs.
6. Insert the upper screw and screw it in slightly.
7. Fit the upper part of the housing and insert the other two screws.
8. Align the housing and tighten the three screws.

Installation

C.2 Electrical connection



Before working on the unit, switch off the power supply and secure it against being switched on again! Check for the absence of power! Electrical connections may only be made by a specialist and in compliance with the applicable regulations. Do not use the controller if the housing shows visible damage.



Low-voltage cables such as temperature sensor cables must be routed separately from mains voltage cables. Feed temperature sensor cables only into the left-hand side of the unit, and mains voltage cables only into the right-hand side.



The customer must provide an all-pole disconnecting device, e.g. a heating emergency switch.



The cables being connected to the unit must not be stripped by more than 55mm, and the cable jacket must reach into the housing just to the other side of the strain relief.

Fig .C.2.1

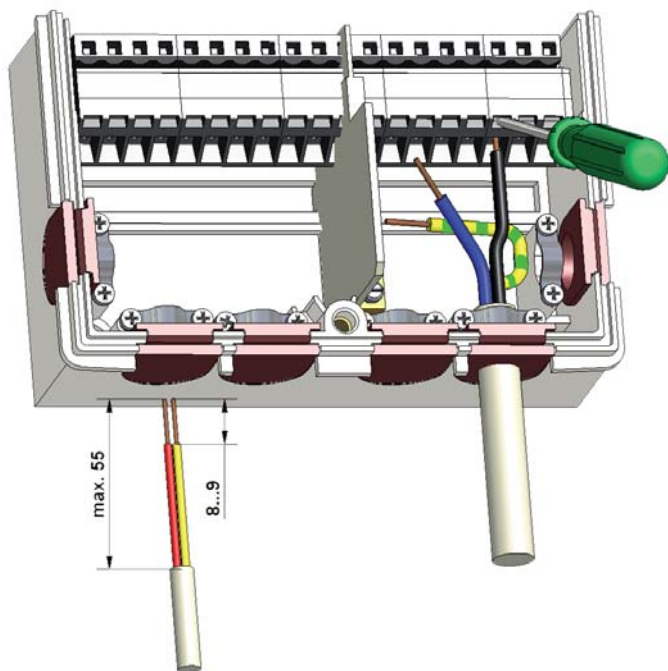

1. Select necessary program/ hydraulics
2. Open controller
3. Strip cables by 55mm max., insert, fit the strain relief devices, strip the last 8-9mm of the wires. (Fig. C.2.1)
4. Open the terminals using a suitable screwdriver (Fig. C.2.1) and make electrical connections on the controller (Page 10)
5. Refit upper part of housing and fasten with screw.
6. Switch on mains voltage and place controller in operation.

Installation

C.2.1

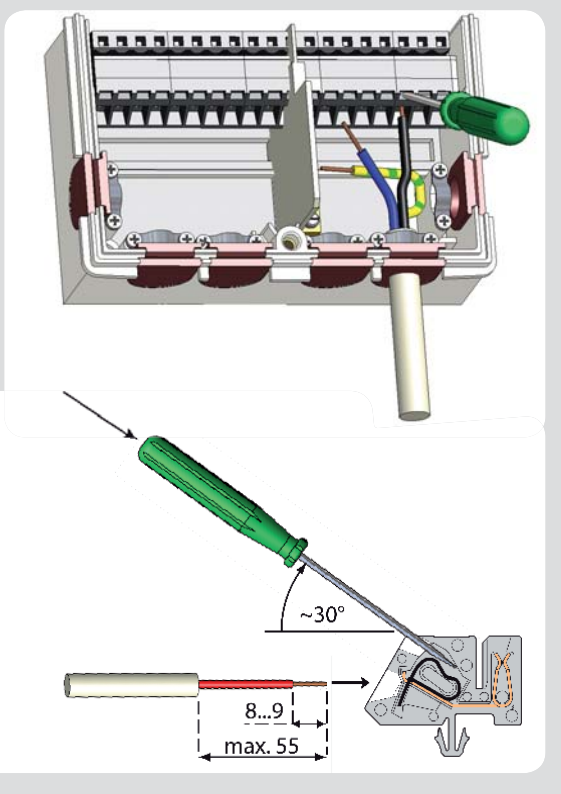

1. Select necessary program/ hydraulics
2. Open controller
3. Strip cables by 55mm max., insert, fit the strain relief devices, strip the last 8-9mm of the wires. (Fig. C.2.1)
4. Open the terminals using a suitable screwdriver (Fig. C.2.1) and make electrical connections on the controller (Page 10)
5. Refit upper part of housing and fasten with screw.
6. Switch on mains voltage and place controller in operation.

C.3 Installing the temperature sensors

The controller operates with Pt1000 temperature sensors which are accurate to the degree, thus ensuring optimal control of system functions.



Caution

If desired the sensor cables can be extended to a maximum of 30m using a cable with a cross-section of at least 0.75mm². Make sure that there is no contact resistance!

Position the sensor precisely in the area to be measured!

Only use immersion, pipe-mounted or flat-mounted sensor suitable for the specific area of application with the appropriate permissible temperature range.



Caution

The temperature sensor cables must be routed separately from mains voltage cables, and must not, for example, be routed in the same cable duct!

Installation

D Terminal connection diagram

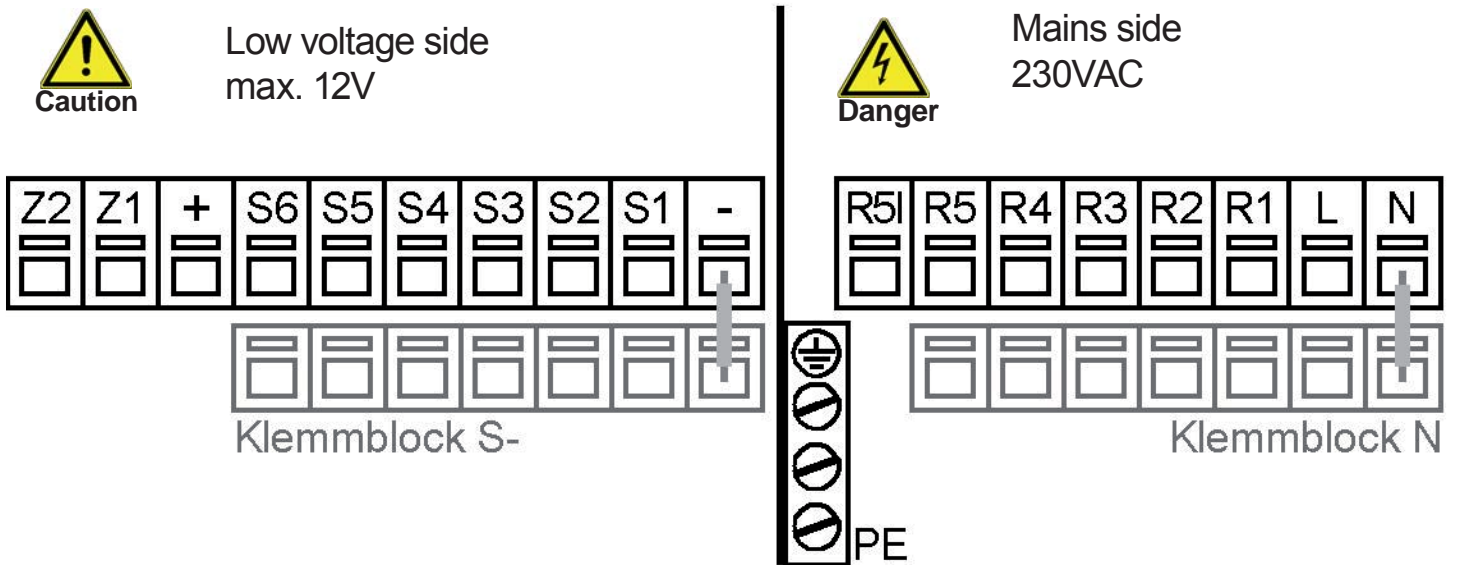

Low voltage max. 12VAC/DC connection in the left-hand terminal compartment!

Terminal:	Connection for:
S1	Primary return
S2	Circulation
S3	Storage middle
S4	Primary flow
S5	VFS hot water (VFS yellow)
S6	VFS flow l/min (VFS white)
+	VFS +5V DC (VFS brown)
-	jumper terminal block-
Z1	GND
Z2	0-10V Pumpe

The polarity of the PT1000 sensors is freely selectable.

Connection of sensor earths (S1-S4) and VFS via terminal block sensor S-

Mains voltage 230VAC 50-60Hz connection in the right-hand terminal compartment!

Terminal:	Connection for:
L	Mains phase conductor L
N	Mains neutral conductor N
R1	Valve (storage middle)
R2	Circulation pump
R3	Mixer open
R4	Mixer close
R5	heat requirement
R5I	heat requirement

The PE protective conductor must be connected to the PE metal terminal block!

Connection of relay lead N via terminal block Sensor N.



Caution

The potential free relay R5 is always switched on for the heat requirement when the 0-10V output is switched on.
Relay 5 can only be used with mains voltage of 230VAC. Never use with low voltage.

Operation

E.1 Display and input

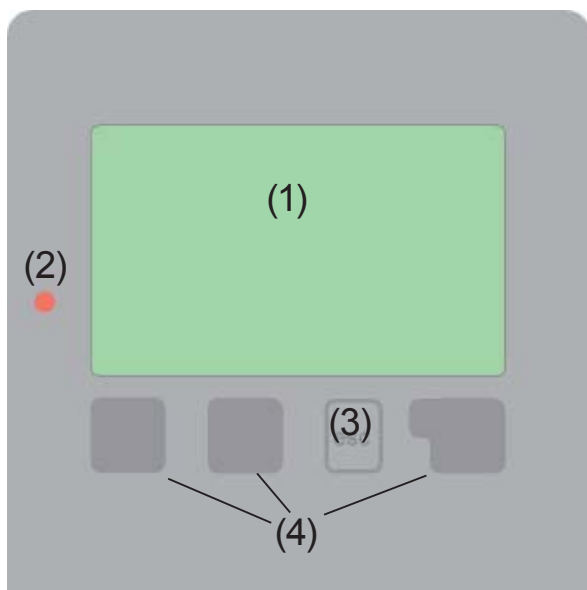

The display (1), with its extensive text and graphics mode, is almost self-explanatory, allowing easy operation of the controller.









The LED (2) lights up green when a relay is switched on.

The LED (2) lights up red when operating mode “Off” is set.

The LED (2) flashes slowly red in the operating mode “Manual”.

The LED (2) flashes quickly red when an error is present.

Examples for display icons:

-  Pump
(rotates when active)
-  Flow meter
-  Heat exchanger
-  temperature probe
-  Mixer
-  Valve
-  Storage
-  Warning / Error message
-  New information

Entries are made using four keys (3+4), which are assigned to different functions depending on the situation. The “esc” key (3) is used to cancel an entry or to exit a menu. If applicable there will be a request for confirmation as to whether the changes which have been made should be saved.

The function of each of the other three keys (4) is shown in the display line directly above the keys; the right-hand key is generally has a confirmation and selection function.

Examples of key functions:

- | | |
|---------|--------------------------|
| +/- | = enlarge/shrink values |
| ▼/▲ | = scroll menu down/up |
| yes/no | = approve/reject |
| Info | = additional information |
| Back | = to previous screen |
| ok | = confirm selection |
| Confirm | = confirm setting |

Parametrisation

E.2 Commissioning help



The first time the controller is turned on and after the language and time are set, a query appears as to whether you want to parametrise the controller using the commissioning help or not. The commissioning help can also be terminated or called up again at any time in the special functions menu. The commissioning help guides you through the necessary basic settings in the correct order, and provides

brief descriptions of each parameter in the display. Pressing the “esc” key takes you back to the previous value so you can look at the selected setting again or adjust it if desired. Pressing the “esc” more than once takes you back step by step to the selection mode, thus cancelling the commissioning help. Finally, menu 4.2 under operating mode “Manual” should be used to test the switch outputs with the consumers connected, and to check the sensor values for plausibility. Then switch on automatic mode.



Caution

Observe the explanations for the the individual parameters on the following pages, and check whether further settings are necessary for your application.

E.3 Free commissioning

If you decide not to use the commissioning help, you should make the necessary settings in the following sequence:

- Menu 6. Special functions - clock
- Menu 5. Settings, complete

Finally, menu 4.2 under operating mode “Manual” should be used to test the switch outputs with the consumers connected, and to check the sensor values for plausibility. Then switch on automatic mode.



Caution

Observe the explanations for the the individual parameters on the following pages, and check whether further settings are necessary for your application.

Operation

E.4 Menu sequence and menu structure

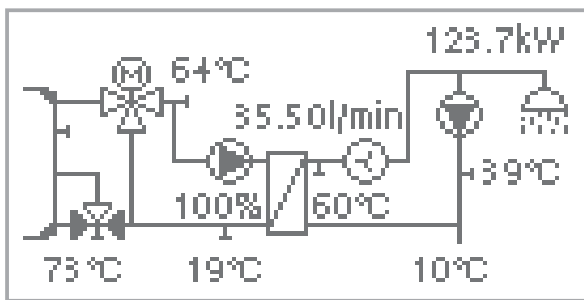

The graphics or overview mode appears when no key has been pressed for 2 minutes, or when the main menu is exited by pressing “esc”.

Pressing a key in graphics or overview mode takes you directly to the main menu. The following menu items are then available for selection there:

1. Measurements

Current temperature values with explanations

2. Statistics

Function control of the system with operating hours, etc.

3. Display Mode

Select graphics mode or overview mode

4. Operating Mode

Automatic mode, manual mode or switch unit off

5. Settings

Set parameters needed for normal operation

6. Special functions

Program selection, clock, etc.

7. Menu lock

Against unintentional setting changes at critical points

8. Service data

For diagnosis in the event of an error

9. Language

Select the menu language

Measurement values

1. - Measurement values



The menu “1. Measurement values” serves to display the currently measured temperatures.

The menu is closed by pressing “esc” or selecting “Exit measurement values”.



Selecting “Info” leads to a brief help text explaining the measurement values.

Selecting “Overview” or “esc” exits the Info mode.



Caution

If “Error” appears on the display instead of the measurement value, then there may be a defective or incorrect temperature sensor.

If the cables are too long or the sensors are not placed optimally, the result may be small deviations in the measurement values. In this case the display values can be compensated for by making entries on the controller. Follow the instructions under 7.3.

What measurement values are displayed depends on the selected program, the connected sensors and the specific device design.



Caution

The temperature shown is the temperature after the heat exchanger and can deviate from the tap water temperature.

Small fluctuations of the tap water temperature are usually compensated by the pipe system.

Statistics

2. - Statistics



The menu “2. Statistics” is used for function control and long-term monitoring of the system.

The menu is closed by pressing “esc” or selecting “Exit statistics”.



Caution

For analysis of the system data it is essential for the time to be set accurately on the controller. Please note that the clock does not continue to run if the mains voltage is interrupted, and must therefore be reset. Improper operation or an incorrect time may result in data being deleted, recorded incorrectly or overwritten.

The manufacturer accepts no liability for the recorded data!

2.1. - Operating hours HW

Display of operating hours of the hot water pump connected to the controller.

2.2. - Operating hours circ.

Display of operating hours of the circulation pump connected to the controller.

2.3. - Heat output

Display of the heat output of the system.



Caution

Resulting data is only approximate value for function control!

2.4. - Graphic overview

This provides a clearly-organised display of the data listed under 2.1-2.3 as a bar graph. Various time ranges are available for comparison. The two left-hand keys can be used to page through the data.

2.5. - Message log

Display of the last 10 events occurring in the system with indication of date and time.

2.6. - Reset/clear

Resetting and deleting the individual analyses. The function “All statistics” clears all analyses but not the error messages.

Display mode

3. - Display mode

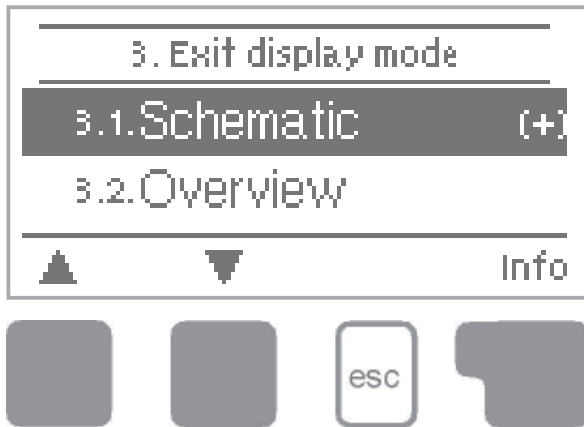

Menu “3. Display mode” is used to define the controller’s display for normal operation.

This display appears whenever two minutes go by without any key being pressed. The main menu appears again when a key is pressed.

The menu is closed by pressing “esc” or selecting “Exit display mode”.

3.1. - Schematic

In graphics mode, the selected hydraulic systems are depicted with the measured temperatures and operating states of the connected consumers.

3.2. - Overview

In overview mode, the measured temperatures and operating states of the connected consumers are depicted in text form.

3.3. - Alternating

In alternating mode the schematic mode and then the overview mode are active for 5 seconds at a time.

Operating modes

4. - Operating modes

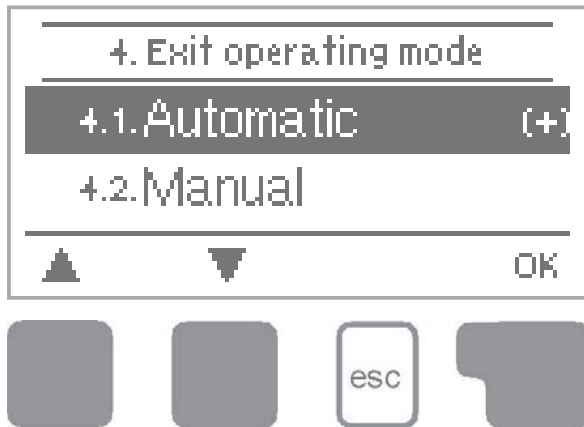

In menu "4. Operating modes" the controller can either be placed in automatic mode, switched off, or placed in a manual operating mode.

The menu is closed by pressing "esc" or selecting "Exit operating modes".

4.1. - Automatic

Automatic mode is the normal operating mode of the controller. Only automatic mode provides proper controller function taking into account the current temperatures and the parameters that have been set! After an interruption of the mains voltage the controller automatically returns to the last operating mode selected!

4.2. - Manual

The relay and thus the connected consumer are switched on and off by pressing a key, with no regard to the current temperatures and the parameters which have been set. The measured temperatures are also shown to provide an overview and function control. The high-efficiency pump is named here "Relay 6", despite the fact that it is connected to the Z terminal.



Danger

When operating mode "Manual" is activated, the current temperatures and the selected parameters are no longer considered. There is a danger of scalding or serious damage to the system. The operating mode "Manual" may only be used by specialists for brief function tests or during commissioning!

4.3. - Off



Caution

When the operating mode "Off" is activated, all controller functions are switched off. This can lead, for example, to overheating on the solar collector or other system components. The measured temperatures are still displayed to provide an overview.

Settings

5. - Settings



The necessary basic settings required for the control function are made in menu “5. Settings”.



This does not under any circumstances replace the safety facilities to be provided by the customer!

The menu is closed by pressing “esc” or selecting “Exit settings”.

5.1. - Tsetpoint

Setpoint at sensor 5

The controller FWC attempts to maintain a constant temperature at sensor 5 by controlling the speed of the hot water pump.

Settings range: 45°C to Tmax-5°C / Default: 61°C

5.2. - Tmax

Maximum temperature at sensor 5

Maximum allowable temperature at sensor 5. If Tmax is exceeded, the pump is switched off. If the temperature drops below Tmax the pump is enabled again.

Settings range: Tset+5°C to 95°C / Default: 71°C



Temperature values which are set too high can lead to scalding or damage to the system. Scalding protection must be provided by the customer!

5.3. - Primary flow Min

Setpoint temperature at the mixer in the primary flow

The setpoint temperature in the primary heat circuit when the flow rate is at its minimum.

Settings range: 40° C bis 69° C / Default setting: 61° C

5.4. - Primary flow Max

Setpoint temperature at the mixer in the primary flow

The setpoint temperature in the primary heat circuit when the flow rate is at its max.

Settings range: 62° C bis 90° C / Default setting: 70° C

Settings

5.5. - Tset S3

Thermostat function at sensor 3

If the temperature at sensor 3 exceeds this value (+hysteresis) the corresponding relay is switched off. If the temperature at sensor 3 falls below this value and the other conditions are also met, the corresponding relay is switched on.

Setting range: from 0°C to 99°C / Default: 50°C

5.6. - Thermostat periods

Thermostat activity times

Set the desired periods of time when the thermostat should be active. 2 periods can be set per day, settings can also be copied to other days. Outside the set times the thermostat is switched off.

Setting range: from 00:00 to 23:59 / Default: 06:00 to 22:00

5.7. - Hysteresis

Hysteresis for thermostat function

By setting the hysteresis value the heating of the storage tank can be adjusted. If the temperature of the Tsetpoint at sensor is exceeded by the set hysteresis, additional heating is deactivated.

Setting range: from 0°C to 20°C / Default: 10°C

5.8. - Cold water

Temperature of the water fed into the system

The temperature of the water for domestic use fed into the system can be set here. This is used to calculate the heat amount.

Settings range: 0°C to 60°C / Default : 10°C

5.9. - VFS-Type

Select the type of flow sensor used.

Settings range: 1-12l/min, 1-20l/min, 2-40l/min, 5-100l/min, 10-200l/min, 20-400l/min

5.10. - Comfort

The heat exchanger is rinsed every 15 minutes to keep it warm.

Settings range: On, Off / Default: Off

Settings

5.11. - Circulation

Operating mode of the circulation

Set the mode of circulation in this menu.

When the mode “**Request**” is active, the circulation pump is switched on after a corresponding withdrawal of water has occurred .

In mode “**Periods**” the circulation pump is enabled in the set periods.

Settings range: Off, Request, Periods / Default: Request

5.12. - Purging time

Operating time of the circulation pump

The circulation pump is switched off after this period of time even if the set temperature is not reached at sensor 2. This is to prevent the pump from unnecessary running, e.g. when the storage buffer is too cold.

Settings range: 1 Min. to 20 Min. / Default: 2 Min.

5.13. - Circulation pause time

Circulation pump pause time

To prevent the pump from frequently switching on and off, this sets the minimum time the pump is not switched on again after being switched off.

Settings range: 1 Min. to 20 Min. / Default: 15 Min.

5.14. - Cirk. Tmin.

Min.Temperature at sensor S2

If the temperature drops below Cirk.Tmin at sensor 2 and the circulation is enabled (see 5.11), or a request due to tapping is present, the circulation pump is started.

Settings range: 10°C bis 40°C / Default : 30°C

5.15. - Circ. hysteresis

Switch-off hysteresis of the circulation

If the temperature exceeds Cirk. Tmin/TminS2 by this value (see 5.11), the circulation pump is switched off.

Settings range: 1K to 20K / Default: 5K

5.16. - Circ. max. FR

Maximum flow rate of the circulation

If the flow rate exceeds this value, the circulation pump is switched off.

Settings range: 1 to 50 l/min / Default: 15 l/min

Settings

5.17. - Circulation period

Period where the circulation pump is enabled

Set the operation times of the circulation pump. 3 different periods can be set for every weekday, which can also be copied to other days.

Settings range: Off/00:00 to 23:59 h/Default: 06:00-22:00 h



Caution

The menu item **Circulation period** is only available while the mode “Periods” is active.



Caution

In periods not defined circulation is inactive.
The set periods are only used in the circulation mode “Periods”.



Caution

Primary and circulation temperature have to be set concerning each other.

Special functions

6. Special functions



Menu “6. Special functions” is used to set basic items and expanded functions.



Caution

Other than the time all settings may only be made by a specialist.

The menu is closed by pressing “esc” or selecting “Exit special functions”.

6.1 Time & Date

This menu is used to set the current time and date.



Caution

For proper functioning of the controller and statistics for the system data it is essential for the time to be set accurately on the controller. Please note that the clock continues to run for about 24 hours if the mains voltage is interrupted, and after that has to be reset.

6.2 Sensor calibration

Deviations in the temperature values displayed, for example due to cables which are too long or sensors which are not positioned optimally, can be compensated for manually here. The settings can be made for each individual sensor in steps of 0.5°C.

Offset S1...S6 per setting range: -10°C...+10°C Default: 0°C



Caution

Settings are only necessary in special cases at the time of initial commissioning by the specialist. Incorrect measurement values can lead to unpredictable errors.

6.3 Commissioning

Starting the commissioning help guides you in the correct order through the basic settings necessary for commissioning, and provides brief descriptions of each parameter in the display.

Pressing the “esc” key takes you back to the previous value so you can look at the selected setting again or adjust it if desired. Pressing the “esc” more than once takes you back to the selection mode, thus cancelling the commissioning help. (see also E.2).



Caution

May only be started by a specialist during commissioning! Observe the explanations for the individual parameters in these instructions, and check whether further settings are necessary for your application.

Special functions

6.4 Factory settings

All of the settings that have been made can be reset, thus returning the controller to its delivery state.



The entire parametrisation, analyses, etc. of the controller will be lost irrevocably. The controller must then be commissioned once again.

6.5 Mixer



Settings are only to be made during the installation by a specialist. Incorrect settings may cause severe malfunctions.

6.5.1 Turn time

The time in seconds the mixer is switched on (opening or closing), before a new measurement for the regulation of the flow temperature is performed.

Settings range: 0.1 sec. to 3 sec. / Default: 2 sec.

6.5.2 Pause factor

Set a value to multiply the calculated pause time with. e.g. a value of 1 would use the calculated pause time, 0.5 would half the pause time, and 4 quadruple the calculated pause time.

Settings range: 0.1 to 4.0 / Default: 3.0

6.5.3 Increase

If a fast increase of temperature occurs, this value is added to the flow temperature, so that the mixer reacts faster. Once the temperature rises no faster, the measured temperature is used again. Temperature is measured once every minute.

Settings range: 0 to 20 / Default: 0

Special functions

6.6 Antilegionella

With the AL-function activated, the controller makes it possible to heat the storage in selectable time periods, for the set residence time (AL resid. time), until the temperature AL Tset is reached.

Additional heating is activated. When AL Tset is reached, the pumps are switched off. 0-10V pump and mixer use AL Tset +1° as reference.

Additional heating is switched off when AL Tset at S3 is exceeded by 5° and switched on again when the temperature drops 1° below AL Tset.

As long as AL is active, Tmax is set to AL Tset +10° to prevent system shutdown.

The condition AL residence time is met when AL Tset +5° is held at S2 for the set time. This is displayed as „AL heat“ in the menu.

When AL was unsuccessful, a new attempt is made at the next enabled time period.

AL Function - Settings range: On or Off/ Default: Off

AL residence time - settings range: 1-60 minutes / Default: 15 minutes

AL times - Settings range: Mo-Su, 0-24h / Default: Daily 3-5

AL heat: Shows the date of the last successful AL heat up



During the anti-Legionella function the storage tank is heated up to high temperatures which can lead to scalding and damage to the system.



When circulation mode “Off” is selected, the Anti Legionella function is also switched off.



The user has to make sure that the antilegionella function was successful at the set intervals.



The AL function is switched off by default.
A message also containing the date is shown as soon as the AL function was completed successful. We recommend to set the „AL start time“ in a period where little or no water is tapped.



The user has to make sure that the storage temperature is AL Tset +5° when starting AL. When the storage sensor S3 is installed: If AL Tset+5° is not reached, the AL function is not started.



This anti-Legionella function does not provide complete protection against Legionella, because the controller is dependent on sufficient energy being fed in.

Special functions

6.7 Speed control

The FWC 5 can control special pumps with 0-10V output.



This function should be activated and parametrised by a specialist only. The specifications of the pump manufacturer have to be observed.

6.7.1 Max. speed

Set the maximum speed of the pump. During the adjustment the pump is running with the according speed and the flow can be measured. 100% approximate 10V, 90% 9V etc.

Settings range: 70 to 100% / Default: 100%

6.7.2 Min. speed

The minimum speed of the pump. During the adjustment the pump is running with the according speed and the flow can be measured.

Settings range: 12 to max speed -5% / Default: 17%

6.7.3 Pump u0

Required for pumps with cable break detection.

Some pumps are running with slow speed when no voltage is present. This setting is used to determine the minimum voltage to switch the pump off.

Settings range: 0 to max 1,5V / Default: 0,7V

6.8 Limescale protection

To prevent the accumulation of limescale, the circulation pump can continue to rinse the heat exchanger after a tapping for a short time.

Settings range: On/Off / Default: Off

6.9 Relay 5

The function of relay 5 is freely selectable.

Thermostat: Temperature- and time controlled additional heating. Necessary settings are shown in menu 5.

Fault indication: Relay is switched on when a malfunction occurs.

AlwaysOn: Relay is always powered on.

Settings range: Off, Thermostat, Fault indication, AlwaysOn

Default: Off

Menu Lock

7. Menu Lock



Menu "7. Menu lock" can be used to secure the controller against unintentional changing of the set values.

The menu is closed by pressing "esc" or selecting "Exit menu lock".



The menus listed below remain completely accessible despite the menu lock being activated, and can be used to make adjustments if necessary:

1. Measurement values
2. Analysis
3. Display mode
8. Menu lock
9. Service values

To lock the other menus, select "Menu lock on".

To enable the menus again, select "Menu lock off".

Setting range: on, off/default setting: off

Service values

8. Service values

8.2. Hot water	45 °C
8.3. Circulation	43 °C
8.4. Cold water	12 °C

The menu “8. Service values” can be used for remote diagnosis by a specialist or the manufacturer in the event of an error, etc.

The menu can be closed at any time by pressing “esc”.



Caution

Enter the values at the time when the error occurs e.g. in the table.

8.1.	
8.2.	
8.3.	
8.4.	
8.5.	
8.6.	
8.7.	
8.8.	
8.9.	
8.10.	
8.11.	
8.12.	
8.13.	
8.14.	
8.15.	
8.16.	
8.17.	
8.18.	
8.19.	
8.20.	
8.21.	
8.22.	
8.23.	
8.24.	
8.25.	
8.26.	
8.27.	
8.28.	
8.29.	
8.30.	

8.31.	
8.32.	
8.33.	
8.34.	
8.35.	
8.36.	
8.37.	
8.38.	
8.39.	
8.40.	
8.41.	
8.42.	
8.43.	
8.44.	
8.45.	
8.46.	
8.47.	
8.48.	
8.49.	
8.50.	
8.51.	
8.52.	
8.53.	
8.54.	
8.55.	
8.56.	
8.57.	
8.58.	
8.59.	
8.60.	

Language

9. Language



Menu “9. Language” can be used to select the language for the menu guidance. This is queried automatically during initial commissioning. The choice of languages may differ, however, depending on the device design. Language selection is not available in every device design!



Malfunctions

Z.1 Malfunctions with error messages

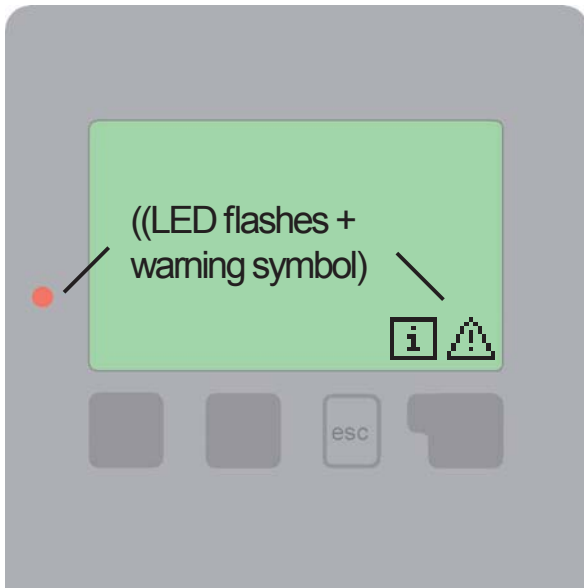

If the controller detects a malfunction, the red light flashes and the warning symbol also appears in the display. If the error is no longer present, the warning symbol changes to an info symbol and the red light no longer flashes.

To obtain more detailed information on the error, press the key under the warning or info symbol.



Do not try to deal with this yourself. Consult a specialist in the event of an error!

Possible error messages:

Sensor x defective -----
---->

Notes for the specialist:

Means that either the sensor, the sensor input at the controller or the connecting cable is/was defective. (Resistance table on page 5)

Time&date ----->

This display appears automatically after a mains failure because the time&date have to be checked, and reset if necessary.

Maintenance

Z.2. Replacing the fuse



Repairs and maintenance may only be performed by a specialist. Before working on the unit, switch off the power supply and secure it against being switched on again! Check for the absence of power!



Only use the supplied spare fuse or a fuse of the same design with the following specifications: T2A 250V

Fig.3.1.1

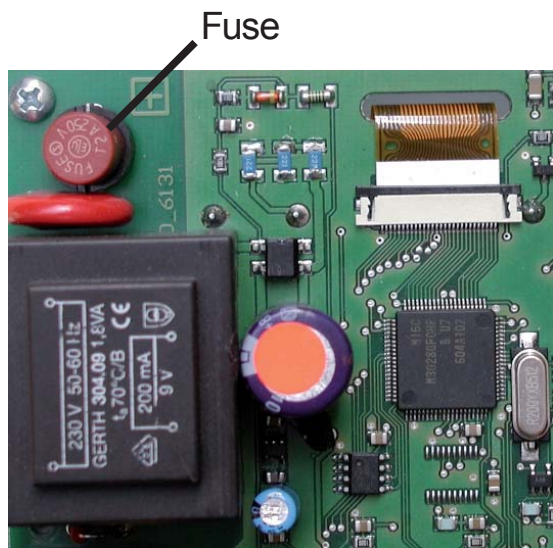

If the mains voltage is switched on and the controller still does not function or display anything, then the internal device fuse may be defective. In that case, open the device as described under 3.1, remove the old fuse and check it. Exchange the defective fuse for a new one, locate the external source of the error (e.g. pump) and exchange it. Then first recommission the controller and check the function of the switch outputs in manual mode as described under 9.2.

Maintenance

Z.3. Maintenance



Caution

In the course of the general annual maintenance of your heating system you should also have the functions of the controller checked by a specialist and have the settings optimised if necessary.

Performing maintenance:

- Check the date and time (see 11.1)
- Assess/check plausibility of analyses (see 7.)
- Check the error memory (see 7.5)
- Verify/check plausibility of the current measurement values (see 6.)
- Check the switch outputs/consumers in manual mode (see 9.2)
- Poss. optimise the parameter settings

Hydraulic variant set:

Commissioned on:

Commissioned by:

Notes:

Final declaration:

Although these instructions have been created with the greatest possible care, the possibility of incorrect or incomplete information cannot be excluded. Subject as a basic principle to errors and technical changes.

Manufacturer:

SOREL GmbH Mikroelektronik

Jahnstr. 36

D - 45549 Sprockhövel

Tel. +49 (0)2339 6024

Fax +49 (0)2339 6025

www.sorel.de info@sorel.de